

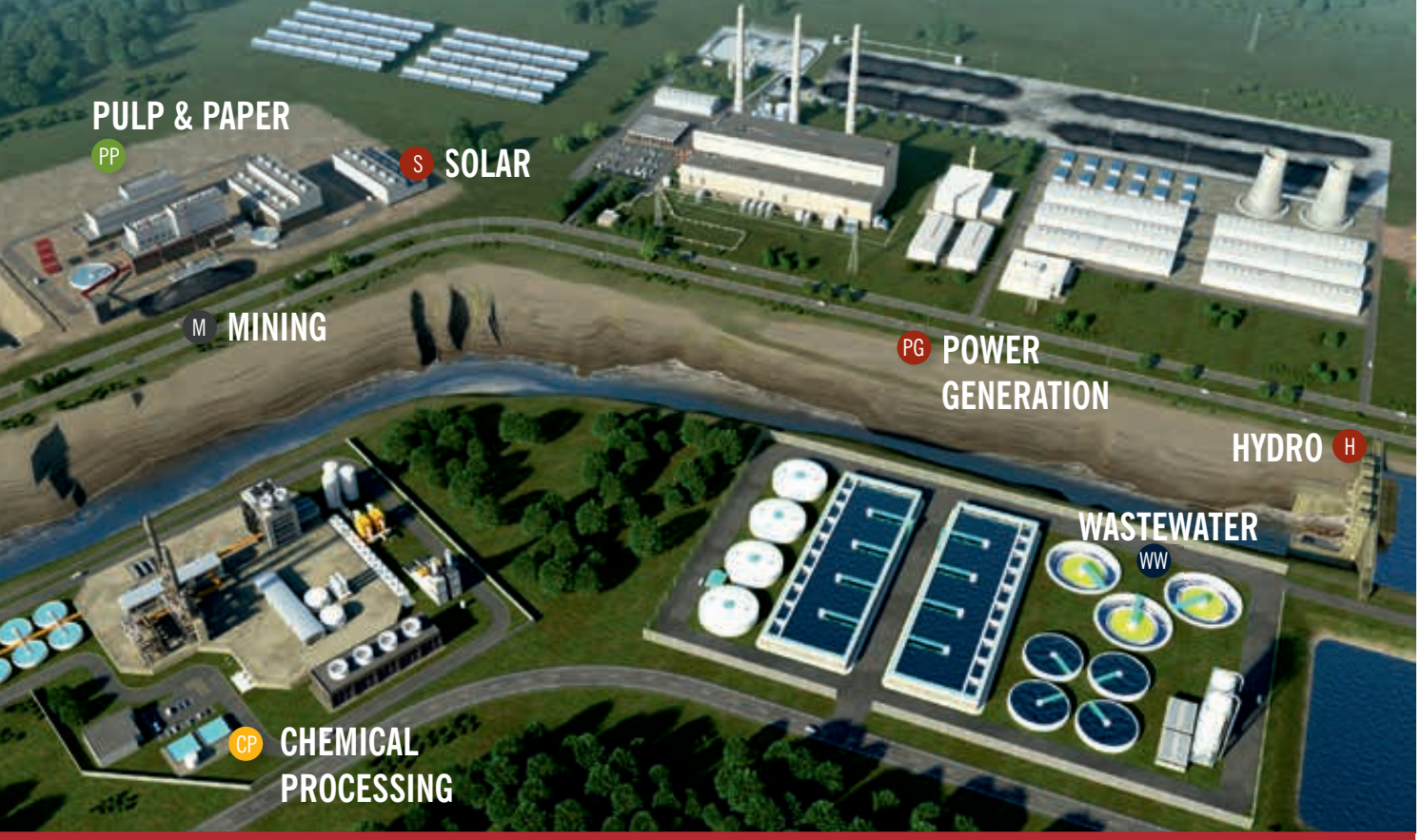

# PRODUCT CATALOG



CHEMICAL PROCESSING MINING PULP & PAPER WASTEWATER BUILDING & CONSTRUCTION FOOD & BEVERAGE TEXTILES HYDRO  
POWER GENERATION SOLAR OIL & GAS MARINE

# REDEFINING WHAT'S POSSIBLE

CIRCOR is redefining what's possible in the oil and gas, power generation, industry and commercial marine markets, collaborating with engineers and operators like you to develop the best fluid-handling solutions for your application.

Your toughest challenges are addressed with more than just an off-the-shelf product when you partner with CIRCOR. You get 150 years of application experience, technology that's relied on to support numerous power and industrial plants every day worldwide, and a team of product and service specialists tasked with maximizing the efficiency of your operation – from the very start to the finish of your project.

All of this is enabled by a broad portfolio of pumps and engineered systems from brands you and your clients know and trust – Allweiler®, Houttuin™, Imo®, Warren® and Zenith® – ensuring that you get the reliability your operations demand and expert levels of service that you require during design, commissioning and throughout operations.

As your single-source global supplier, we call this "Total Savings of Ownership (TSO)" reducing the overall costs of your operation and increasing your profitability.

**Note:**

Please note that performance data and construction characteristics of our products may change due to continuous optimization and development. Please check [www.circorpt.com](http://www.circorpt.com) for the latest release of this brochure.

# PRODUCT OVERVIEW

## PRODUCTS AND SYSTEMS YOU CAN RELY ON FROM START TO FINISH

---

The challenges you face in the global processing and manufacturing industry, in power generation, oil and gas and shipbuilding can be daunting. The critical process application requirements and broad market dynamics you need to deal with every day are constantly changing. Your manufacturing and production technologies are often unique, complex and sometimes among the most regulated in the world. Whether you are producing **energy, chemicals, fuels, ship technology, plastics and textiles, paints and coatings, pharmaceuticals, food and beverages, pulp and paper or processing wastewater**, the goal of all businesses remains essentially the same: to design or maintain processes that meet or exceed production schedules and minimize expensive downtime. Innovative and time-tested for precision performance, our pumps, systems and solutions for these applications withstand any number of rigors, from high temperature and low viscosity to unique needs for hygienic design or handling fluids with solids and fibers. Whatever the application requirement, CIRCOR meets your exacting needs with a wide range of pump technologies that work for you.

### THREE-SCREW PUMPS

Design with only three rotating parts, pulse-free flow with extremely low vibration and noise levels, and high-pressure boost capabilities, even when handling low-viscosity fluids.

Page 4

### TWO-SCREW PUMPS

Versatile self-priming horizontal and vertical screw pumps with tremendous product viscosity range for lubricating and non-lubricating liquids.

Page 18

### PROGRESSING CAVITY PUMPS

Simple and economical pump design requiring only one shaft seal, able to handle fluids contaminated with large percentages of abrasive solids.

Page 28

### CENTRIFUGAL PUMPS

Custom designed to specific application requirements with a wide range of low viscosity aggressive and non-aggressive fluids, and a dynamically balanced impeller to reduce vibration.

Page 36

### PROPELLER PUMPS

Pump design for large volumes, delivery heads up to 20 meters

Page 46

### SIDE CHANNEL PUMPS

Side channel designs fill the hydraulic performance gap between positive displacement pumps and centrifugal pumps.

Page 50

### EXTERNAL/INTERNAL GEAR PUMPS

Pumps for true precision metering, with accurate delivery under varying conditions of pressure, temperature and viscosity.

Page 54

### PERISTALTIC PUMPS

Dry self-priming, seal-less and valve-less design for low to highly viscous liquids, pasty, neutral or aggressive, pure or abrasive, gaseous or tending to froth, also with fibrous and solids content.

Page 60

### MACERATORS

Macerators crush fibers and solids contained in liquids and make them pumpable.

Page 62

### SMART SOLUTIONS

The revolutionary CIRCOR SmartTechnology Platform expands and improves pump monitoring and control capabilities. The results are dramatically lower maintenance and energy costs, elevated safety, and optimized control for bringing the pump to the desired operating point.

Page 64

### ENGINEERED SYSTEMS

Lubrication systems, dry gas seal systems, packaged units, point-to-point box lubricators and other highly engineered systems to CIRCOR customers in the oil and gas, commercial marine, power and industry markets.

Page 66

Note: Performance data with 50 Hz speeds of rotation; other performance data on request.



## THREE-SCREW PUMPS

The ALLWEILER® and IMO® three-screw pumps are rotary, self-priming positive displacement pumps. The pumping elements consist of three moving parts: the power rotor (main screw) and two symmetrically opposed idler rotors, all operating within close fitting housing bores. The incoming process fluid is conveyed by the rotating power rotor by means of the cavity formed with the intermeshing idler rotors.

From suction to discharge, the fluid is transferred by means of a series of constantly forming and re-forming chambers until it reaches the casing outlet. Symmetrical pressure loading on the power rotor eliminates the need for radial bearings to absorb radial forces. The idler rotors generate a hydrodynamic film, which provides radial support similar to journal bearings. Axial loads on the power rotor and idler rotors, created by differential pressure, are hydrostatically balanced. With this design arrangement, high differential pressures can be managed.

### Strengths of the technology

- High pressure boost capabilities even when handling low viscosity fluids
- Pump with one of the highest overall efficiencies when aligned with only three rotating parts
- Virtually pulse-free flow with extremely low vibration and noise levels

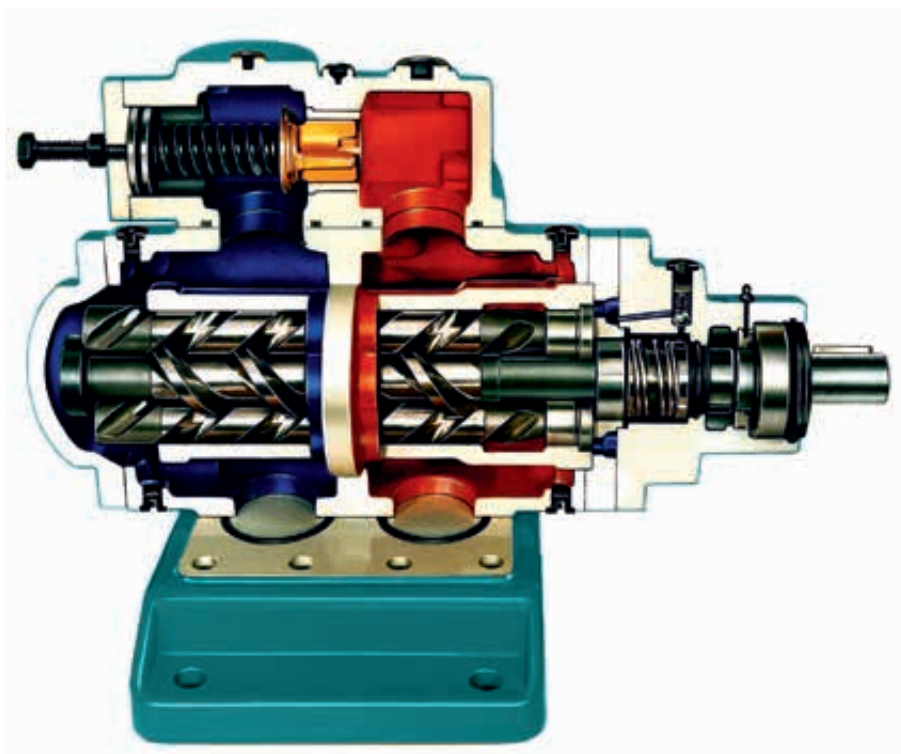

## Maximizing TSO\* due to

### Long service life

Hardened and ground screws; hydraulically driven idler spindles that are not subject to any wear.

### Reliable operation

As overload protection a built-on-pressure relief valve is possible.

### Low maintenance

Internal bearing lubricated by pumped liquid or external bearing grease lubricated.

### Easy maintenance

Complete insert unit dismountable. The pump casing remains in the piping.

### Flexible configuration

Shaft sealing alternatively by shaft seal rings, mechanical seal or magnetic coupling according to the operating conditions.

\*Total Savings of Ownership

## Main Applications

Utilized in all segments of industry where lubricating liquids are pumped that do not contain abrasive components, and which will not chemically attack the pump materials, e. g. heavy and diesel oil, circulation of lubricating and hydraulic oils.

### General advantages of the three-screw pumps at a glance:

- Self-priming
- Virtually no pulsation
- Wide viscosity range
- High thermal resistance
- Low operating noise
- Very good efficiency
- Low wear
- Reliable during operation
- Compact space-saving design
- Long service life

# THREE-SCREW PUMPS: Maximum Performance Data and Construction Characteristics

## Pumped liquid

Water	<b>Water</b>
Wastewater	<b>Waste</b>
Oil, lubricating fluids	<b>Oil</b>
Coolant lubricants	<b>Cool</b>
Heat carrier liquids	<b>Heat</b>
Chemicals	<b>Chem</b>
Food, beverage, cosmetics, pharmaceuticals	<b>Food</b>



Series		12L		VH	
Max. flow rate	GPM l/min	100	379	343	1,300
Max. discharge pressure	PSIG bar	4,500	310	4,061	280
Viscosity	mm <sup>2</sup> /s	4 to 5,400		3 to 1,500	
Max. fluid temperature	°F °C			302	150
Horizontal/vertical installation		●/-		-/●	
Wall/pedestal mounting		-/-		●/-	
Dry installation		●		●	
In-tank installation		-		●	
Magnetic coupling		-		-	

## Pumped liquid

Water	<b>Water</b>
Wastewater	<b>Waste</b>
Oil, lubricating fluids	<b>Oil</b>
Coolant lubricants	<b>Cool</b>
Heat carrier liquids	<b>Heat</b>
Chemicals	<b>Chem</b>
Food, beverage, cosmetics, pharmaceuticals	<b>Food</b>



Series		12D		8L	
Max. flow rate	GPM l/min	400	1,514	2,900	10,978
Max. discharge pressure	PSIG bar	2,200	151	2,000	138
Viscosity	mm <sup>2</sup> /s	4 to 5,400		10 to 5,400	
Max. fluid temperature	°F °C	225	107	225	107
Horizontal/vertical installation		●●		●/-	
Wall/pedestal mounting		-/-		-/-	
Dry installation		●		●	
In-tank installation		-		-	
Magnetic coupling		-		-	



Oil

SD



Oil

6U/6T



Oil

SE

55	210	200	757	15	55
3,046	210	2,500	172	2,321	160
3 to 760		4 to 5,400		3 to 380	
176	80			176	80
-/●		●/●		●/●	
●/-		-/-		-/-	
●		●		-	
●		-		●	
-		-		-	



Oil Cool

EMTEC



Oil Cool

EMTEC-C



Oil

SM

264	1,000	80	581	2,200
1,886	130	100	1,740	120
1 to 2,000		1 to 760		1 to 5,000
176	80	80	392	200
●/●		●/●		●/●
-/-		-/-		●/●
●		●		●
●		●		●
-		-		-

# THREE-SCREW PUMPS: Maximum Performance Data and Construction Characteristics

## Pumped liquid

Water	<b>Water</b>
Wastewater	<b>Waste</b>
Oil, lubricating fluids	<b>Oil</b>
Coolant lubricants	<b>Cool</b>
Heat carrier liquids	<b>Heat</b>
Chemicals	<b>Chem</b>
Food, beverage, cosmetics, pharmaceuticals	<b>Food</b>



Series	SNA		CFHM	
Max. flow rate	GPM	l/min	880	232 880
Max. discharge pressure	PSIG	bar	20	1,740 120
Viscosity	mm <sup>2</sup> /s		10 to 760	3 to 760
Max. fluid temperature	°F	°C	100	212 100
Horizontal/vertical installation	●/●		●/●	
Wall/pedestal mounting	-/-		●/-	
Dry installation	●		●	
In-tank installation	●		●	
Magnetic coupling	-		-	

## Pumped liquid

Water	<b>Water</b>
Wastewater	<b>Waste</b>
Oil, lubricating fluids	<b>Oil</b>
Coolant lubricants	<b>Cool</b>
Heat carrier liquids	<b>Heat</b>
Chemicals	<b>Chem</b>
Food, beverage, cosmetics, pharmaceuticals	<b>Food</b>



Series	SN		SN-M(B)	
Max. flow rate	GPM	l/min	1,400 5,300	925 3,500
Max. discharge pressure	PSIG	bar	928 64	928 64
Viscosity	mm <sup>2</sup> /s		1 to 5,000	2 to 5,000
Max. fluid temperature	°F	°C	302 150	302 150
Horizontal/vertical installation	●/●		●/●	
Wall/pedestal mounting	●/●		●/●	
Dry installation	●		●	
In-tank installation	●		-	
Magnetic coupling	-		●	



SF		SU & 4PIC		TRITEC	
15	55	217	820	219	830
1,450	100	1,160	80	1,160	25
3 to 760		3 to 380		0.3 to 2,000	
176	80	158	70	212	100
●/●		●/●		●/-	
-/-		-/-		-/-	
-		-		●	
●		●		-	
-		-		-	

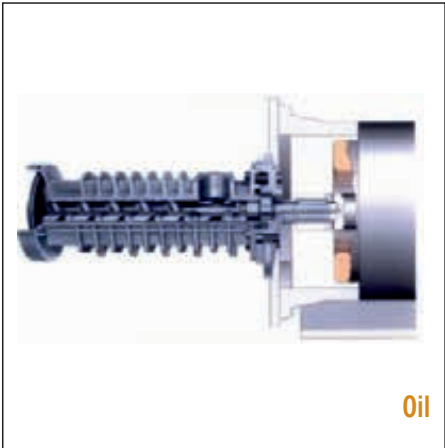

RU		AFI		AFI-F	
217	820	30	112	30	112
725	50	580	40	580	40
3 to 380		1 to 750		1 to 750	
158	70	302	150	302	150
●/●		●/●		-/●	
-/-		●/●		-/●	
-		●		●	
●		●		-	
-		-		-	

# THREE-SCREW PUMPS: Maximum Performance Data and Construction Characteristics

## Pumped liquid

Water	<b>Water</b>
Wastewater	<b>Waste</b>
Oil, lubricating fluids	<b>Oil</b>
Coolant lubricants	<b>Cool</b>
Heat carrier liquids	<b>Heat</b>
Chemicals	<b>Chem</b>
Food, beverage, cosmetics, pharmaceuticals	<b>Food</b>



Series	AFI-T		AFM			
Max. flow rate	GPM	l/min	30	112	30	112
Max. discharge pressure	PSIG	bar	580	40	580	40
Viscosity	mm <sup>2</sup> /s		1 to 750		1 to 3,000	
Max. fluid temperature	°F	°C	302	150	302	150
Horizontal/vertical installation			-/●		●/●	
Wall/pedestal mounting			-/●		●/●	
Dry installation			●		●	
In-tank installation			-		-	
Magnetic coupling			-		●	

## Pumped liquid

Water	<b>Water</b>
Wastewater	<b>Waste</b>
Oil, lubricating fluids	<b>Oil</b>
Coolant lubricants	<b>Cool</b>
Heat carrier liquids	<b>Heat</b>
Chemicals	<b>Chem</b>
Food, beverage, cosmetics, pharmaceuticals	<b>Food</b>

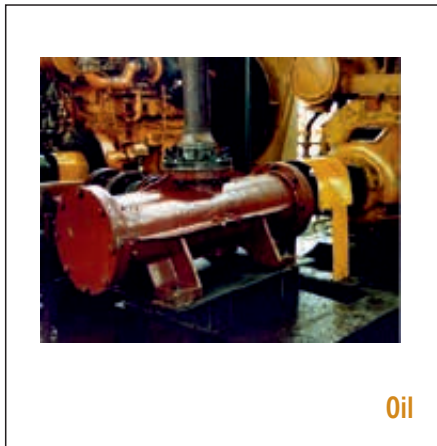

Series	T324N		324A-Series			
Max. flow rate	GPM	l/min	800	3,033	900	3,400
Max. discharge pressure	PSIG	bar	500	34	500	34
Viscosity	mm <sup>2</sup> /s		11 to 4,320		11 to 43,200	
Max. fluid temperature	°F	°C	500	260	500	260
Horizontal/vertical installation			●/●		●/●	
Wall/pedestal mounting			-/-		-/-	
Dry installation			●		●	
In-tank installation			-		-	
Magnetic coupling			●		-	



Oil

AFM-F



Oil

AFM-T

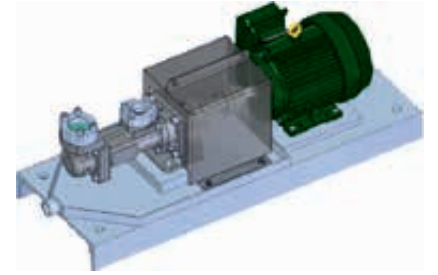

Oil

CFHN

30	112	30	112	200	757
580	40	580	40	580	40
1 to 750		1 to 750		2 to 650	
302	150	302	150	212	100
-/●		-/●		●/●	
-/●		-/●		●/-	
●		●		●	
-		-		-	
●		●		-	

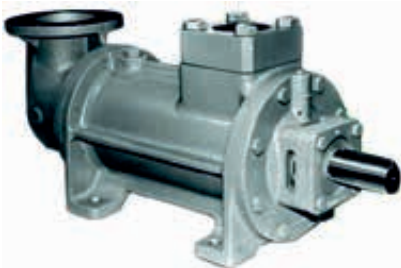

Oil

3D



Oil

3L



Oil

323F-Series

400	1,514	200	757	3,300	12,500
500	34	500	34	300/500	21/34
2 to 3,250		2 to 3,200		11 to 43,200	
250	121			500	260
●/●		●/●		●/●	
●/-		-/-		-/-	
●		●		●	
●		●		-	
-		-		-	

# THREE-SCREW PUMPS: Maximum Performance Data and Construction Characteristics

## Pumped liquid

Water	<b>Water</b>
Wastewater	<b>Waste</b>
Oil, lubricating fluids	<b>Oil</b>
Coolant lubricants	<b>Cool</b>
Heat carrier liquids	<b>Heat</b>
Chemicals	<b>Chem</b>
Food, beverage, cosmetics, pharmaceuticals	<b>Food</b>



Oil

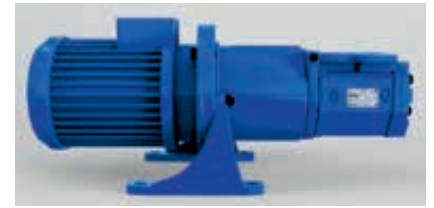

Oil

Series	3G		ACE Standard			
Max. flow rate	GPM	l/min	200	757	47	180
Max. discharge pressure	PSIG	bar	250	17	232	16
Viscosity	mm <sup>2</sup> /s		2 to 3,200		1.4 to 3,500	
Max. fluid temperature	°F	°C	225	107	311	155
Horizontal/vertical installation			●●		●●	
Wall/pedestal mounting			●/-		●●	
Dry installation			●		●	
In-tank installation			●		-	
Magnetic coupling			-		-	

## Pumped liquid

Water	<b>Water</b>
Wastewater	<b>Waste</b>
Oil, lubricating fluids	<b>Oil</b>
Coolant lubricants	<b>Cool</b>
Heat carrier liquids	<b>Heat</b>
Chemicals	<b>Chem</b>
Food, beverage, cosmetics, pharmaceuticals	<b>Food</b>

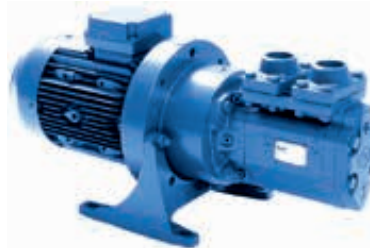

Oil



Oil

Series	TRILUB TRE		TRILUB TRF			
Max. flow rate	GPM	l/min	42	158	766	2,900
Max. discharge pressure	PSIG	bar	232	16	232	16
Viscosity	mm <sup>2</sup> /s		1.4 to 3,500		1.4 to 5,000	
Max. fluid temperature	°F	°C	311	155	266	130
Horizontal/vertical installation			●●		●●	
Wall/pedestal mounting			●●		●●	
Dry installation			●		●	
In-tank installation			●		●	
Magnetic coupling			-		-	



Oil



Oil

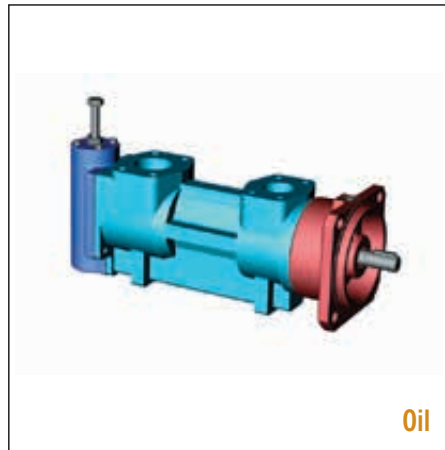

Oil

ACG/UCG Standard

ALLUB RUV

TRILUBTRL

316	1,200	343	1,300	232	880
232	16	232	16	232	16
1.4 to 3,500		3 to 760		3 to 760	
311	155	212	100	176	80
●/●		-/●		●/●	
●/●		-/-		●/●	
●		-		●	
-		●		●	
-		-		-	



Oil



Oil



Oil

TRILUBTRQ

2BIC

3E

2,087	7,900	70	265	100	379
150	10	175	12	150	10
2 to 800		2 to 216		2 to 5,400	
194	90	180	82	250	121
-/●		●/●		●/●	
-/●		-/-		●/-	
●		●		●	
●		●		●	
-		-		-	

# THREE-SCREW PUMPS: Maximum Performance Data and Construction Characteristics

## Pumped liquid

Water	<b>Water</b>
Wastewater	<b>Waste</b>
Oil, lubricating fluids	<b>Oil</b>
Coolant lubricants	<b>Cool</b>
Heat carrier liquids	<b>Heat</b>
Chemicals	<b>Chem</b>
Food, beverage, cosmetics, pharmaceuticals	<b>Food</b>



Series		TRILUBTRD		AFT	
Max. flow rate	GPM l/min	11	42	29	108
Max. discharge pressure	PSIG bar	102	7	87	6
Viscosity	mm <sup>2</sup> /s	1.4 to 1,500		1.4 to 380	
Max. fluid temperature	°F °C	194	90	302	150
Horizontal/vertical installation		●/●		●/●	
Wall/pedestal mounting		●/●		●/●	
Dry installation		●		●	
In-tank installation		●		-	
Magnetic coupling		-		-	

## Pumped liquid

Water	<b>Water</b>
Wastewater	<b>Waste</b>
Oil, lubricating fluids	<b>Oil</b>
Coolant lubricants	<b>Cool</b>
Heat carrier liquids	<b>Heat</b>
Chemicals	<b>Chem</b>
Food, beverage, cosmetics, pharmaceuticals	<b>Food</b>



Series		ACD		ACE Optiline	
Max. flow rate	GPM l/min	11	42	46	175
Max. discharge pressure	PSIG bar	102	7	232	16
Viscosity	mm <sup>2</sup> /s	1.4 to 1,500		1.4 to 1,500	
Max. fluid temperature	°F °C	194	90	356	180
Horizontal/vertical installation		●/●		●/●	
Wall/pedestal mounting		●/●		●/●	
Dry installation		●		●	
In-tank installation		-		-	
Magnetic coupling		-		●	



Oil

AFT-F



Oil

AFT-T



Oil

LPD

29	108	29	108	5	20
87	6	87	6	147	10
1.4 to 380		1.4 to 380		1.4 to 600	
302	150	302	150	194	90
-/●		-/●		●/●	
-/●		-/●		●/●	
●		●		●	
-		-		-	
-		-		-	



Oil

LPE Standard



Oil

LPE Optiline



Oil

ACG Optiline

47	180	46	175	311	1,180
232	16	232	16	232	16
1.4 to 3,500		1.4 to 1,500		1.4 to 1,500	
311	155	356	180	356	180
●/●		●/●		●/●	
●/●		●/●		●/●	
●		●		●	
-		-		-	
-		●		●	

# THREE-SCREW PUMPS: Maximum Performance Data and Construction Characteristics

## Pumped liquid

Water	<b>Water</b>
Wastewater	<b>Waste</b>
Oil, lubricating fluids	<b>Oil</b>
Coolant lubricants	<b>Cool</b>
Heat carrier liquids	<b>Heat</b>
Chemicals	<b>Chem</b>
Food, beverage, cosmetics, pharmaceuticals	<b>Food</b>



Oil



Oil

Series		ACF/UCF		LPQ	
Max. flow rate	GPM l/min	763	2,900	2,079	8,100
Max. discharge pressure	PSIG bar	232	16	232	16
Viscosity	mm <sup>2</sup> /s	1.4 to 5,000		2 to 800	
Max. fluid temperature	°F °C	266	130	194	90
Horizontal/vertical installation		●●		-/●	
Wall/pedestal mounting		●●		-/●	
Dry installation		●		●	
In-tank installation		-		-	
Magnetic coupling		-		-	

## Pumped liquid

Water	<b>Water</b>
Wastewater	<b>Waste</b>
Oil, lubricating fluids	<b>Oil</b>
Coolant lubricants	<b>Cool</b>
Heat carrier liquids	<b>Heat</b>
Chemicals	<b>Chem</b>
Food, beverage, cosmetics, pharmaceuticals	<b>Food</b>



Oil



Oil

Series		4T		6D	
Max. flow rate	GPM l/min	200	757	400	1,514
Max. discharge pressure	PSIG bar	1,500	103	1,500	103
Viscosity	mm <sup>2</sup> /s	2 to 3,200		4 to 5,400	
Max. fluid temperature	°F °C			250	121
Horizontal/vertical installation		●●		●●	
Wall/pedestal mounting		-/●		-/-	
Dry installation		●		●	
In-tank installation		-		●	
Magnetic coupling		-		-	



Oil

E4



Oil

D4



Oil

D6

E4		D4		D6	
266	1,010	276	1.050	237	900
1,471	100	2,353	160	3,676	250
12 to 400		2 to 400		1.6 to 400	
194	90	311	155	311	155
●/●		●/●		●/●	
●/●		●/●		●/●	
●		●		●	
●		●		●	
-		-		-	

## COMMERCIAL MARINE

### GLOBAL SOLUTIONS



#### ENGINE ROOM

- Ballast
- Cooling water (sea & fresh)
- Hot-water circulation
- Fuel & lubricating oil
- Hydrophore
- Boiler feed
- Sewage & sanitary services
- General service
- Condensate
- Firefighting
- Bilge
- Main LO circulation
- Sludge
- Gearbox services
- Electric propulsion
- Motor cooling
- Trim/weight compensation



#### CARGO SPACE / PROPULSION

- Aircraft fuel transfer
- Firefighting
- Wash down
- Deluge
- Hydraulics



#### BOILER ROOM

- Firefighting pumps
- Weapons cooling
- Hydraulics
- Hot water circulation
- Condensate transfer
- Thermal oil circulation
- Thermal oil filling
- Boiler water feed
- Fuel oil booster burner



#### DECK MACHINERY

- Hydraulics
- Air con
- Water transfer
- Winch lubrication
- Firefighting water transfer
- Cooling water transfer
- Power pack circulation (equipment, complete unit)
- Cargo handling



© coolibri-Fotolia.com

## TWO-SCREW PUMPS

Manufactured under the brand names Houttuin and Warren, this technology utilizes two intermeshing screws synchronized by a set of external timing gears, which are assembled into a close fit figure-eight-shaped housing. The operating principle employed is based on the non-contacting concept of positive displacement (“PD”) pumps, which means a combination of timing gears are used to prevent the screws from touching each other. In addition, radial bearings orienting the screws position in the bores permits this technology to defy the capabilities of many PD pumps offered in the industry for non-lubricating fluids.

With no need for contacting surfaces and no dependence on fluid film support, two-screw pumps can be made using many different materials. They operate at a wide range of speeds while dealing with conventional and unconventional fluids with properties like ultra-low and ultra-high viscosity, gas entrainment, contamination and corrosives.

This technology is particularly suitable for industries, whose fluids are non-Newtonian, shear sensitive, have high vapor pressures, varying viscosities, and whose processes are solvent flushed, heated, batched or drained.

### Strengths of the technology

- Tolerates contamination
- Large range of viscosity
- Runs dry
- Low shear
- Variable speed

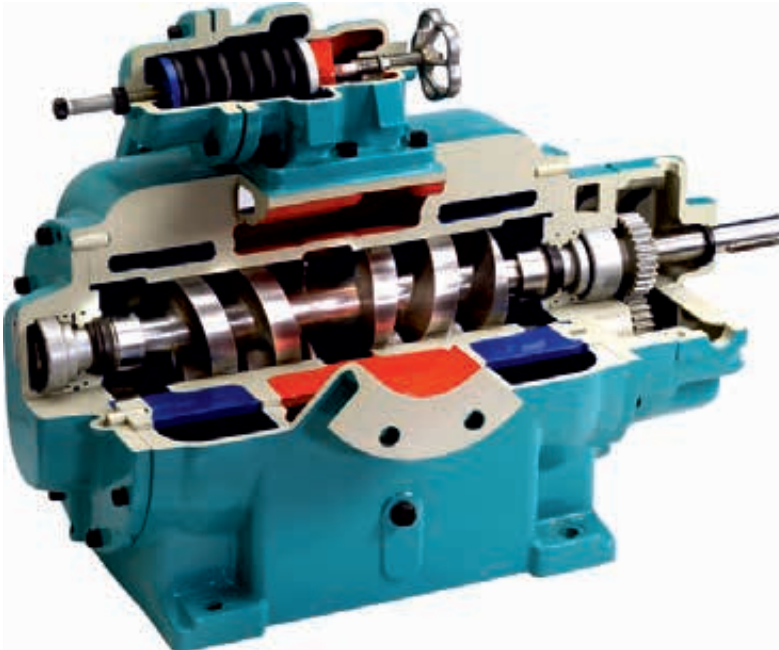

### Maximizing TSO\* due to

#### Long service life

Precision gears prevent screw contact by maintaining a constant space between the screws, resulting in less wear on the screws.

#### Insensitive

Insensitive to impurities because there is no metal contact between the screw-shafts and the cylinder bore.

#### High performance

High suction capability due to good sealing of intermeshing screw profiles.

\*Total Savings of Ownership

### Main Applications

The Warren and Houttuin Pumps are used worldwide in the chemical and petrochemical industry, tank farms, power plants, offshore, refineries, shipbuilding and marine, soap, food, beverage, plastics and sugar industries.

#### General advantages of the two-screw pumps at a glance:

- Wide range of materials
- High temperature up to 698 °F/370 °C
- High flows up to 22,000 gpm/5,000 m<sup>3</sup>/h
- Low NPSH value

## TWO-SCREW PUMPS: Maximum Performance Data and Construction Characteristics

### Pumped liquid

Water	<b>Water</b>
Wastewater	<b>Waste</b>
Oil, lubricating fluids	<b>Oil</b>
Coolant lubricants	<b>Cool</b>
Heat carrier liquids	<b>Heat</b>
Chemicals	<b>Chem</b>
Food, beverage, cosmetics, pharmaceuticals	<b>Food</b>



**Oil Chem**



**Oil Chem**

### Series

J10 – J20

J30 – J50

		J10 – J20		J30 – J50	
Max. flow rate	GPM l/min	40	150	100	378
Max. discharge pressure	PSIG bar	1,000	69	1,000	69
Viscosity	mm <sup>2</sup> /s	1 to 1,000,000		1 to 1,000,000	
Max. fluid temperature	°F °C	650	343	650	343
Horizontal/vertical installation		●/-		●/-	
Wall/pedestal mounting		-/-		-/-	
Dry installation		●		●	
In-tank installation		-		-	
Magnetic coupling		-		-	

### Pumped liquid

Water	<b>Water</b>
Wastewater	<b>Waste</b>
Oil, lubricating fluids	<b>Oil</b>
Coolant lubricants	<b>Cool</b>
Heat carrier liquids	<b>Heat</b>
Chemicals	<b>Chem</b>
Food, beverage, cosmetics, pharmaceuticals	<b>Food</b>



**Oil**



**Oil**

### Series

360 – 2030 FSXA

2530 – 4550 FSXA

		360 – 2030 FSXA		2530 – 4550 FSXA	
Max. flow rate	GPM l/min	1,900	7,190	4,500	17,000
Max. discharge pressure	PSIG bar	1,400	97	1,400	97
Viscosity	mm <sup>2</sup> /s	0.5 to 100,000		1 to 100,000	
Max. fluid temperature	°F °C	225	107	225	107
Horizontal/vertical installation		●/-		●/-	
Wall/pedestal mounting		-/-		-/-	
Dry installation		●		●	
In-tank installation		-		-	
Magnetic coupling		-		-	

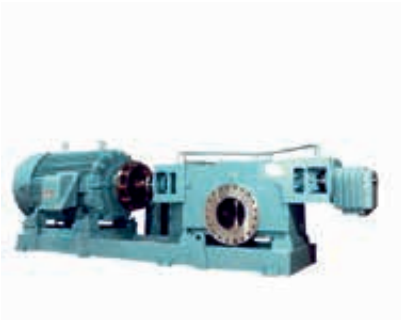

Oil Chem



Oil Chem

J60 – J70

J80

300 1,135

500 34

1 to 1,000,000

650 343

●/-

-/-

●

-

-

450 1,700

400 28

1 to 1,000,000

650 343

●/-

-/-

●

-

-



Oil



Oil

2030 – 3830 FSXB

4550 – 8930 FSXB

3,700 14,000

1,500 103

1 to 100,000

225 107

●/-

-/-

●

-

-

8,200 31,000

1,500 103

1 to 100,000

225 107

●/-

-/-

●

-

-

## TWO-SCREW PUMPS: Maximum Performance Data and Construction Characteristics

### Pumped liquid

Water	<b>Water</b>
Wastewater	<b>Waste</b>
Oil, lubricating fluids	<b>Oil</b>
Coolant lubricants	<b>Cool</b>
Heat carrier liquids	<b>Heat</b>
Chemicals	<b>Chem</b>
Food, beverage, cosmetics, pharmaceuticals	<b>Food</b>



Series	GTS 074		GTS 133			
Max. flow rate	GPM	l/min	100	375	730	2,800
Max. discharge pressure	PSIG	bar	300	20	450	31
Viscosity	mm <sup>2</sup> /s		972,000		972,000	
Max. fluid temperature	°F	°C				
Horizontal/vertical installation			-/-		-/-	
Wall/pedestal mounting			●/●		●/●	
Dry installation			●		●	
In-tank installation			-		-	
Magnetic coupling			-		-	

### Pumped liquid

Water	<b>Water</b>
Wastewater	<b>Waste</b>
Oil, lubricating fluids	<b>Oil</b>
Coolant lubricants	<b>Cool</b>
Heat carrier liquids	<b>Heat</b>
Chemicals	<b>Chem</b>
Food, beverage, cosmetics, pharmaceuticals	<b>Food</b>



Series	GTS 400			
Max. flow rate	GPM	l/min	6,000	22,700
Max. discharge pressure	PSIG	bar	300	20
Viscosity	mm <sup>2</sup> /s		972,000	
Max. fluid temperature	°F	°C		
Horizontal/vertical installation			-/-	
Wall/pedestal mounting			●/●	
Dry installation			●	
In-tank installation			-	
Magnetic coupling			-	

## MULTIPHASE PUMPING

### UTILIZE ONE PUMP TO BOOST COMPLETE,

In cases where pump systems see frequent or consistent gas volume fractions above 50%, a multiphase system offers advantages that very often warrant consideration for system and process optimization. Because of this, dynamic, multiphase systems are used primarily in production settings. However, multiphase systems can also be utilized in terminal and refinery transfer and unloading applications.

In a production setting, multiphase systems add hydraulic energy to the unprocessed production stream in order to generate higher flow rates over longer distances making longer tie backs possible before separation.



Oil

GTS 170



Oil

GTS 208



Oil

GTS 268

GTS 170		GTS 208		GTS 268	
1,500	5,700	2,700	10,200	4,000	15,150
600	41	600	41	450	31
972,000		972,000		972,000	
-/-		-/-		-/-	
●/●		●/●		●/●	
●		●		●	
-		-		-	
-		-		-	

## SYSTEMS

### UNTREATED PRODUCTION FLOWS

The conventional method of managing multiphase fluids was to separate the liquid and gas streams at upstream batteries, with the natural gas being either flared off or in some cases boosting the gas back to a Central Processing Facility. Both methods were deemed harmful from an environmental impact standpoint, and because of the added site and support equipment complexity and cost. This led to the need for the development of a new line of pumping technology, which eventually became known as Multiphase. Multiphase pumps handle the raw, production fluid stream with no pretreatment or conditioning of the fluid. They are designed to operate in near continuous upset mode due to the widely varying pressures, temperatures and fluid composition from the wells. The pumps not only eliminate harmful flaring and reduce the equipment footprint, but they also reduce the backpressure on the wells and introduce additional energy into the upstream gathering system, thereby accelerating the total output from the reservoirs. The added benefit of this revolutionary technology is the increased throughput of valuable process fluids in both depleted, low-producing wells and/or enhanced production over the life cycle of newly developed wells. This also provides a more homogeneous flow pattern in the overall piping network, helping to eliminate solids settling and downstream gas pocket obstructions. As experience bears out, Multiphase pumps and their associated systems require a special degree of fluid-conveying expertise to engineer, manufacture and support. Designing automated systems that are fully integrated into your production operation require careful consideration of all operational and life cycle aspects related to the specific production facility. The systems must be safe and dependable to support your demanding production needs. The CIRCOR multiphase system has been modularized to provide you with adaptable features that meet requirements of various applications and environments. Moreover, CIRCOR Multiphase systems can be stacked in parallel creating additional flow beyond individual units. The pump technologies used in multiphase systems are Progressing Cavity Pumps and Two-Screw Pumps.

## TWO-SCREW PUMPS: Maximum Performance Data and Construction Characteristics

### Pumped liquid

Water	<b>Water</b>
Wastewater	<b>Waste</b>
Oil, lubricating fluids	<b>Oil</b>
Coolant lubricants	<b>Cool</b>
Heat carrier liquids	<b>Heat</b>
Chemicals	<b>Chem</b>
Food, beverage, cosmetics, pharmaceuticals	<b>Food</b>



**Waste Chem Food**



**Oil**

Series		136.20		211.10	
Max. flow rate	GPM l/min	88	333	2,157	8,167
Max. discharge pressure	PSIG bar	154	11	224	16
Viscosity	mm <sup>2</sup> /s	0.6 to 1,500		20 to 760	
Max. fluid temperature	°F °C	176	80	176	80
Horizontal/vertical installation		●/-		-/●	
Wall/pedestal mounting		-/-		-/●	
Dry installation		●		●	
In-tank installation		-		-	
Magnetic coupling		-		-	

### Pumped liquid

Water	<b>Water</b>
Wastewater	<b>Waste</b>
Oil, lubricating fluids	<b>Oil</b>
Coolant lubricants	<b>Cool</b>
Heat carrier liquids	<b>Heat</b>
Chemicals	<b>Chem</b>
Food, beverage, cosmetics, pharmaceuticals	<b>Food</b>



**Oil**



**Oil**

Series		216.40		229.10	
Max. flow rate	GPM l/min	2,356	8,917	4,403	16,667
Max. discharge pressure	PSIG bar	224	16	224	16
Viscosity	mm <sup>2</sup> /s	0.6 to 1,500		20 to 760	
Max. fluid temperature	°F °C	212	100	176	80
Horizontal/vertical installation		●/-		●/-	
Wall/pedestal mounting		-/-		-/-	
Dry installation		●		●	
In-tank installation		-		-	
Magnetic coupling		-		-	



Oil

211.40



Oil

215.10

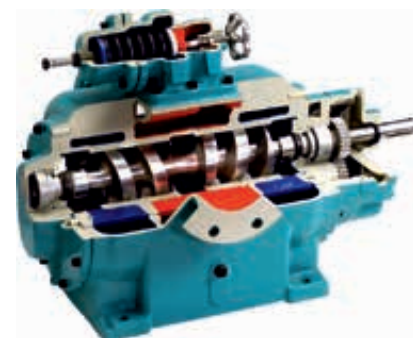

Oil

216.10

2,356	8,917
224	16
0.6 to 1,500	
212	100
-/●	
-/●	
●	
-	
-	

2,157	8,167
150	10
20 to 760	
176	80
-/●	
-/-	
-	
●	
-	

2,356	8,917
224	16
20 to 760	
176	80
	●/-
	-/-
	●
	-
	-



Oil

231.50



Water Oil Chem

236.40



Oil Chem

249.40

2,356	8,917
224	16
0.6 to 5,000	
284	140
-/●	
-/●	
●	
-	
-	

4,403	16,667
224	16
0.6 to 5,000	
284	140
	●/-
	-/-
	●
	-
	-

4,500	20,000
290	20
1 to 100,000	
284	140
	●/-
	-/-
	●
	-
	-

# TWO-SCREW PUMPS: Maximum Performance Data and Construction Characteristics

## Pumped liquid

Water	<b>Water</b>
Wastewater	<b>Waste</b>
Oil, lubricating fluids	<b>Oil</b>
Coolant lubricants	<b>Cool</b>
Heat carrier liquids	<b>Heat</b>
Chemicals	<b>Chem</b>
Food, beverage, cosmetics, pharmaceuticals	<b>Food</b>



Series	300		MR-MULTIPHASE		
Max. flow rate	GPM	l/min	22,014	83,333	up to 2,000,000 SCFN
Max. discharge pressure	PSIG	bar	1,160	80	Gas Fractions to 99 %
Viscosity	mm <sup>2</sup> /s		0.5 to 100,000		Multiphase Oil
Max. fluid temperature	°F	°C	750	400	
Horizontal/vertical installation			●/-		●/-
Wall/pedestal mounting			-/-		-/-
Dry installation			●		-
In-tank installation			-		-
Magnetic coupling			-		-

## PRODUCTS YOU NEED WHEN AND WHERE YOU NEED THEM

Whether in the jungles of Colombia, the deserts of the Sahara or the icy waters of the polar circle, you can depend on CIRCOR to meet your oil and gas needs. Our global presence and industry-leading product application experience ensure you get the right answer, no matter whether you produce, transport, store or refine. And because you're working with a unique company that knows where the fluid comes from and where it needs to go, you can always count on maximum efficiency, reliability, output and uptime.

CIRCOR has worked with customers around the world to match or meet product performance requirements of published standards. Examples include API 676, API 614, API 682 and NACE. Our product portfolio focuses on positive displacement pump technology and extends to multiphase, lubrication and gas compression systems.

	Progressing cavity	Two-screw
Field Gathering Pumps	X	X
Heater Treater Charge Pumps	X	X
Free Water Knockout Pumps	X	X
Desalter Bottoms Pumps	X	X
Multiphase Pumps	X	X
Multiphase Systems		
Gas Compression Systems		
Water Injection Systems		

# OIL & GAS

## GLOBAL SOLUTIONS

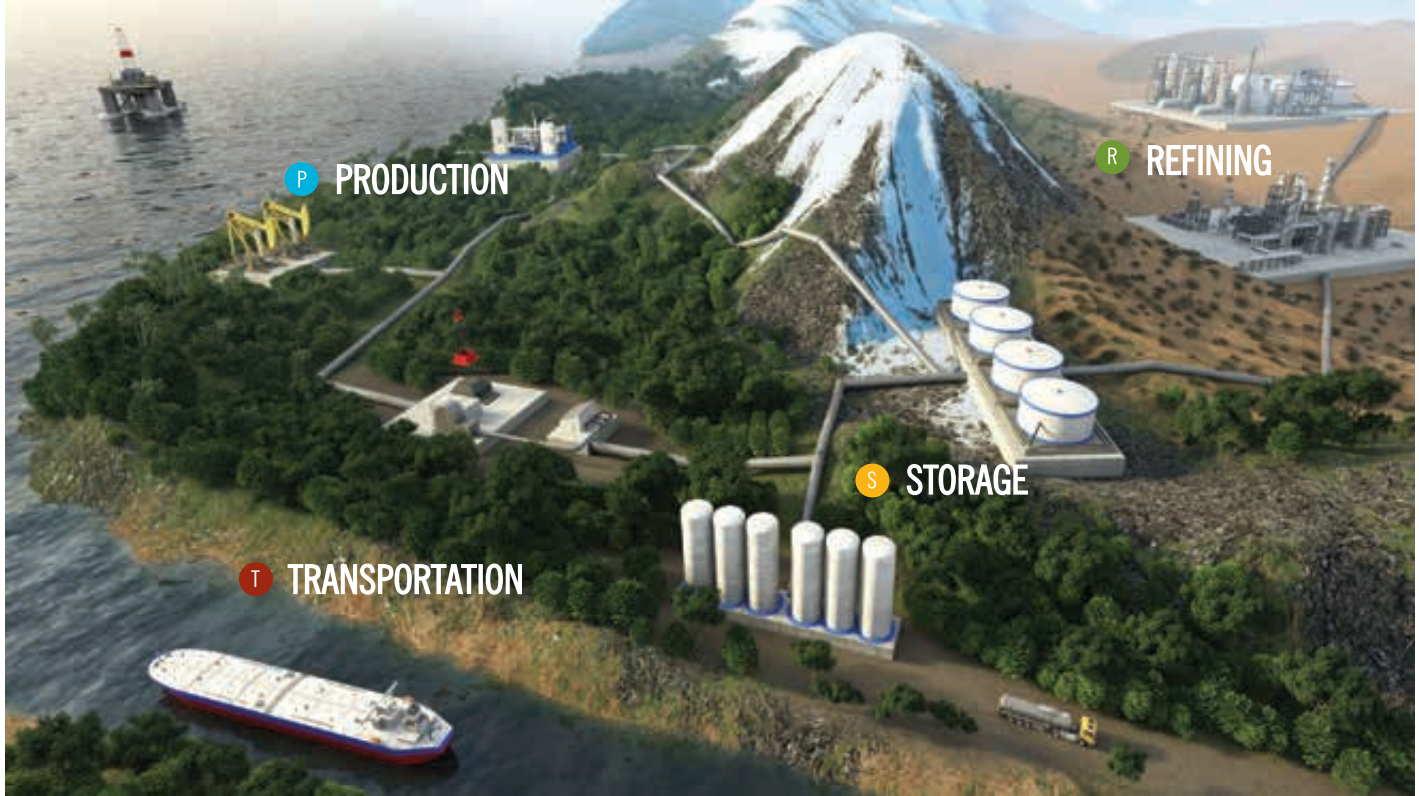

Three-screw	Engineered systems	Progressing cavity	Two-screw	Three-screw	Gear
X		X	X	X	
X			X	X	
			X	X	
				X	X
					X
	X				
	X				
	X				



## PROGRESSING CAVITY PUMPS

Progressing cavity pumps are self-priming, rotary displacement pumps for handling and dosing low to high-viscous, neutral or aggressive, pure or abrasive, gaseous liquids or liquids which tend to froth, even with fiber and solids content. The pumping elements of the self-priming progressing cavity pumps are the rotating rotor and the stationary stator. CIRCOR's Allweiler® brand produces stators and rotors at its own factory in Germany.

ALLDUR® stators – available exclusively from Allweiler® brand – ensure the highest possible durability and economic efficiency. With ALLDUR® stators, you can now pump even extremely abrasive liquids economically and with minimal outlay for maintenance and spare parts!

Allweiler® brand progressing cavity pumps are characterized by high pumping and metering accuracy and continuous, extremely gentle, low pulsation pumping. The liquid structure remains intact during pumping. Allweiler® brand progressing cavity pumps display excellent self-priming features, also with dry substance content up to 45 %. Allweiler® progressing cavity pumps are available in all common materials, making them ideal not only for industrial use, but also (in stainless and CIP versions) for food and beverage production and the pumping of pharmaceuticals and cosmetics.

### Strengths of the technology

- Continuous, extremely gentle, low pulsation pumping
- Excellent self-priming features
- Dry substance content up to 45 %
- Also available in stainless and CIP versions



**Maximizing TSO\* due to**

**Low maintenance and spare part costs**

Patented, zero-play stub shaft connection, internal bearing, removable bearing bracket, high-quality joint design, joint are protected against overpressure and solids, and are lifetime-lubricated with oil.

**Maximum efficiency**

Greater power density with innovative 1/2-screw pumping elements, stators with uniform clamping and special scaled, facet-like surface.

**Low energy requirements**

Rotors with lower friction, shaft seal with very small diameter and up to 50% lower friction loss.

**\*Total Savings of Ownership**

**Main Applications**

Utilized in all segments of chemical and petrochemical industries, but also for wastewater and environmental engineering, food and pharmaceutical industry, pulp and paper industry.

**General advantages of the progressing cavity pumps at a glance:**

- No deposits inside the casing
- Easy disassembly
- No bridge forming
- Easy to maintain
- Vibration-free, higher operating speeds, longer service lives
- Shaft sealing variable

# PROGRESSING CAVITY PUMPS: Maximum Performance Data and Construction Characteristics

## Pumped liquid

Water	<b>Water</b>
Wastewater	<b>Waste</b>
Oil, lubricating fluids	<b>Oil</b>
Coolant lubricants	<b>Cool</b>
Heat carrier liquids	<b>Heat</b>
Chemicals	<b>Chem</b>
Food, beverage, cosmetics, pharmaceuticals	<b>Food</b>



Series	AEB-DE		ALL-OPTIFIX	
Max. flow rate	GPM	l/min	33	1,600
Max. discharge pressure	PSIG	bar	24	10
Viscosity	mm <sup>2</sup> /s		28,000	190,000
Max. fluid temperature	°F	°C	100	100
Horizontal/vertical installation	●/●		●/-	
Wall/pedestal mounting	-/-		-/-	
Dry installation	-		-	
In-tank installation	-		-	
Magnetic coupling	-		-	

## Pumped liquid

Water	<b>Water</b>
Wastewater	<b>Waste</b>
Oil, lubricating fluids	<b>Oil</b>
Coolant lubricants	<b>Cool</b>
Heat carrier liquids	<b>Heat</b>
Chemicals	<b>Chem</b>
Food, beverage, cosmetics, pharmaceuticals	<b>Food</b>



Series	TECFLOW AE1L		AEB.E-IE			
Max. flow rate	GPM	l/min	713	2,700	766	2,900
Max. discharge pressure	PSIG	bar	232	16	232	16
Viscosity	mm <sup>2</sup> /s		200,000		300,000	
Max. fluid temperature	°F	°C	302	150	212	100
Horizontal/vertical installation	●/-		●/-		●/-	
Wall/pedestal mounting	-/●		-/●		-/●	
Dry installation	●		●		●	
In-tank installation	-		-		-	
Magnetic coupling	-		-		-	



ALL-OPTIFLOW AEB1F		ALL-OPTIFLOW AE1F		TECFLOW AEB1L	
1,004	3,800	1,004	3,800	713	2,700
232	16	232	16	232	16
300,000		300,000		200,000	
212	100	275	135	212	100
●/-		●/-		●/-	
-/●		-/●		-/●	
●		●		●	
-		-		-	
-		-		-	



AE.E-ID		AEB.N-IE		AE.N-ID	
1,981	7,500	489	1,850	1,281	4,850
232	16	174	16	232(363)	16 (25)
300,000		270,000		270,000	
302	150	212	100	302	150
●/-		●/-		●/-	
-/●		-/●		-/●	
●		●		●	
-		-		-	
-		-		-	

# PROGRESSING CAVITY PUMPS: Maximum Performance Data and Construction Characteristics

## Pumped liquid

Water	<b>Water</b>
Wastewater	<b>Waste</b>
Oil, lubricating fluids	<b>Oil</b>
Coolant lubricants	<b>Cool</b>
Heat carrier liquids	<b>Heat</b>
Chemicals	<b>Chem</b>
Food, beverage, cosmetics, pharmaceuticals	<b>Food</b>



Series	AEB.4H-IE		AE.H-ID			
Max. flow rate	GPM	l/min	53	200	766	2,900
Max. discharge pressure	PSIG	bar	363	25	363	25
Viscosity	mm <sup>2</sup> /s		270,000		270,000	
Max. fluid temperature	°F	°C	212	100	302	150
Horizontal/vertical installation	●/-		●/-		●/-	
Wall/pedestal mounting	-/●		-/●		-/●	
Dry installation	●		●		●	
In-tank installation	-		-		-	
Magnetic coupling	-		-		-	

## Pumped liquid

Water	<b>Water</b>
Wastewater	<b>Waste</b>
Oil, lubricating fluids	<b>Oil</b>
Coolant lubricants	<b>Cool</b>
Heat carrier liquids	<b>Heat</b>
Chemicals	<b>Chem</b>
Food, beverage, cosmetics, pharmaceuticals	<b>Food</b>



Series	AEB-ZE		AE-ZD			
Max. flow rate	GPM	l/min	198	750	449	1,700
Max. discharge pressure	PSIG	bar	348	24	552	36
Viscosity	mm <sup>2</sup> /s		1,000,000		1,000,000	
Max. fluid temperature	°F	°C	212	100	302	150
Horizontal/vertical installation	●/-		●/-		●/-	
Wall/pedestal mounting	-/●		-/●		-/●	
Dry installation	●		●		●	
In-tank installation	-		-		-	
Magnetic coupling	-		-		-	



Waste Chem Food



Food



Food

AE.V-ID		ALLCLEAN ACNBP		ALLCLEAN ACNP	
502	1,900	127	480	127	480
928	64	174	12	174	12
270,000		150,000		150,000	
302	150	212	100	266	130
●/-		●/-		●/-	
-/●		-/●		-/●	
●		●		●	
-		-		-	
-		-		-	



Waste Chem Food



Food



Food

AE.N-RG		AEB1E-ME		AEB-SE	
132	500	185	700	238	900
363	25	116	8	174	12
1,000,000		150,000		150,000	
302	150	113	45	176	80
●/-		●/-		●/-	
-/●		-/●		-/●	
●		●		●	
-		-		-	
-		-		-	

# PROGRESSING CAVITY PUMPS: Maximum Performance Data and Construction Characteristics

## Pumped liquid

Water	<b>Water</b>
Wastewater	<b>Waste</b>
Oil, lubricating fluids	<b>Oil</b>
Coolant lubricants	<b>Cool</b>
Heat carrier liquids	<b>Heat</b>
Chemicals	<b>Chem</b>
Food, beverage, cosmetics, pharmaceuticals	<b>Food</b>



Series		SMP2		AFP	
Max. flow rate	GPM l/min	24	92	12	47
Max. discharge pressure	PSIG bar	87	6	87	6
Viscosity	mm <sup>2</sup> /s	11,500		50,000	
Max. fluid temperature	°F °C	140	60	113	45
Horizontal/vertical installation		●/-		-/●	
Wall/pedestal mounting		-/●		-/-	
Dry installation		●		-	
In-tank installation		-		●	
Magnetic coupling		-		-	

## Pumped liquid

Water	<b>Water</b>
Wastewater	<b>Waste</b>
Oil, lubricating fluids	<b>Oil</b>
Coolant lubricants	<b>Cool</b>
Heat carrier liquids	<b>Heat</b>
Chemicals	<b>Chem</b>
Food, beverage, cosmetics, pharmaceuticals	<b>Food</b>



Series		SETBP		SETP	
Max. flow rate	GPM l/min	177	670	621	2,350
Max. discharge pressure	PSIG bar	145	10	145	10
Viscosity	mm <sup>2</sup> /s	150,000		300,000	
Max. fluid temperature	°F °C	212	100	302	150
Horizontal/vertical installation		-/●		-/●	
Wall/pedestal mounting		●/-		●/-	
Dry installation		-		-	
In-tank installation		●		●	
Magnetic coupling		-		-	

**ALLDUR®:**

**ORIGINAL ALLWEILER® ALLDUR® STATORS: UP TO FIVE-TIMES LONGER SERVICE LIFE, EVEN WITH ABRASIVE LIQUIDS**

**SIGNIFICANTLY LOWER COSTS FOR SPARE PARTS**

CIRCOR's Allweiler® brand progressing cavity pumps with ALLDUR® stators

**Up to five-times longer service life**

- Ready to handle heavy and dynamic loads
- High impact resilience
- Low compression set
- High tear-growth resistance
- High aging resistance
- Extreme durability

**HERE'S WHAT YOU CAN EXPECT:**

- Extremely high wear resistance
- Up to 500% longer service life (MTBF)
- Longer maintenance intervals
- Less downtime (MTTR)
- Lower maintenance costs
- Extended pump service life

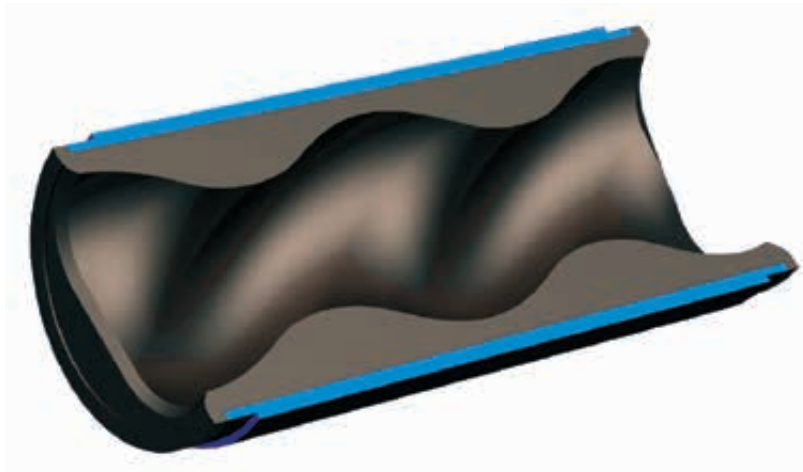

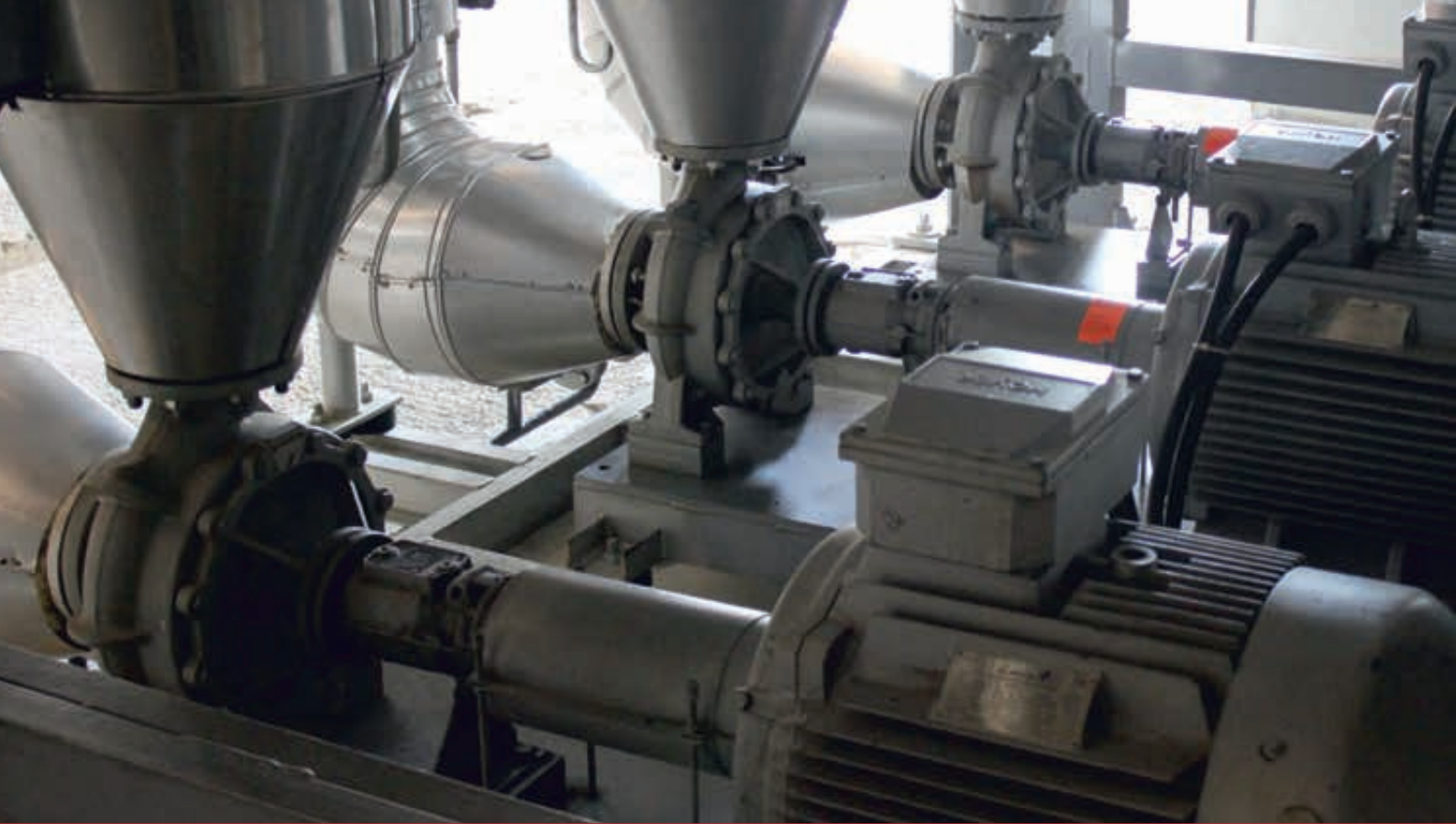

## CENTRIFUGAL PUMPS

---

With a centrifugal pump you can handle neutral or aggressive, pure or contaminated, cold or hot, toxic liquids and liquids that are harmful to the environment. Our centrifugal pumps comply with DIN EN 733 or DIN EN ISO 2858 or are based in terms of their denomination, rated power or dimensions on these industry standards. Additional sizes expand the performance ranges defined by the standards. Series construction according to the modular system ensures rapid delivery times and a smaller stock of spare parts.

Pumps will be supplied for horizontal or vertical installation, for pedestal or wall mounting or in submersible design in accordance with the respective series.

The shaft is sealed by means of gland packings or maintenance-free, uncooled or cooled, unbalanced or balanced, single- or double-acting components, or cartridge mechanical seals. Hermetically sealed pumps with magnetic coupling and a patented safety concept are also available. Non-self-priming pump designs can be provided with manually or automatically controlled deaerating devices. Electric motors or other drive systems are provided as standard for impulsion.

### Strengths of the technology

- Handling light viscosity liquids and support process operations
- Safe handling of dangerous fluids due to magnetic coupling
- Modular design
- High efficiency

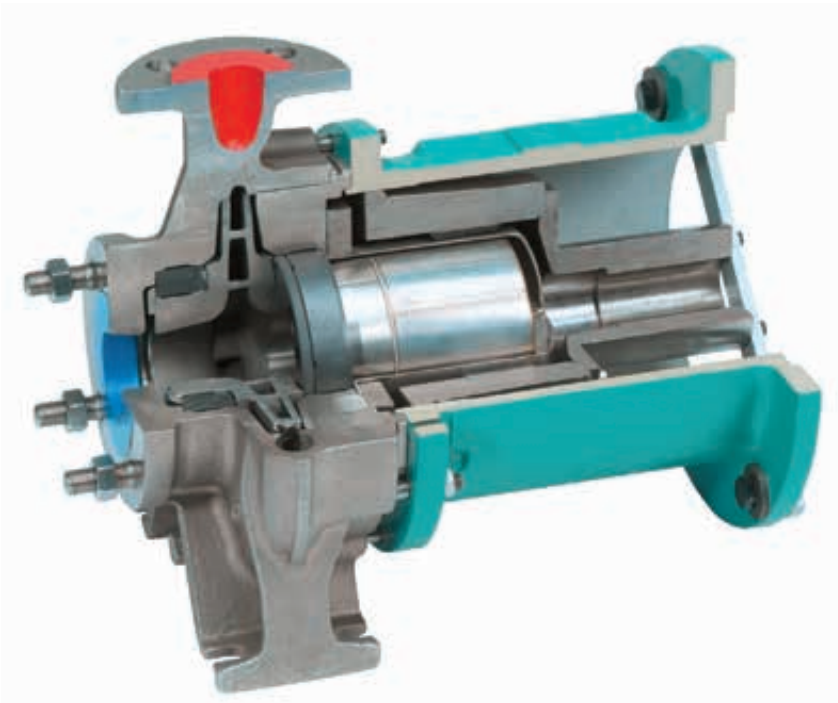

## Maximizing TSO\* due to

### Operational safety

Large SiC bearing and symmetrical impeller result in low axial and radial loads as well as optimal distribution of forces onto the bearing (series CMA).

### Economic operation

Standardized parts and a small number of components keep stocks and replacement parts costs low.

### Reliable operation

Optimal cooling of the containment can with magnetic coupling. No dead space and no deposits in the flushing flow because the shaftless design produces a short, straight flow.

**\*Total Savings of Ownership  
(in particular for magnetic  
couplings)**

## Main Applications

Pumping of water and hot water, lubricating and heat transfer oils, emulsions and chemical products.

### General advantages of the centrifugal pumps at a glance:

- Virtually continuous pumping that is largely pulsation-free.
- High-speed, directly coupled electric motors minimize dimensions and space requirements.
- Adapts well to varying operating conditions.
- The small number of rotating parts results in a simple, highly reliable design.
- Low operating and maintenance costs compared to other pump technologies.

# CENTRIFUGAL PUMPS: Maximum Performance Data and Construction Characteristics

### Pumped liquid

Water	<b>Water</b>
Wastewater	<b>Waste</b>
Oil, lubricating fluids	<b>Oil</b>
Coolant lubricants	<b>Cool</b>
Heat carrier liquids	<b>Heat</b>
Chemicals	<b>Chem</b>
Food, beverage, cosmetics, pharmaceuticals	<b>Food</b>



Series			NT		NB	
Max. flow rate	GPM	m <sup>3</sup> /h	10,158	2,300	2,113	480
Max. discharge pressure	PSIG	bar	145/232	10/16	232	10/16
Delivery head	ft	m	328/476*	100/145*	328/476	100/145*
Max. fluid temperature	°F	°C	284	140	284	140
Horizontal/vertical installation			●/-		●/●	
Wall/pedestal mounting			-/-		●/-	
Dry installation			●		●	
In-tank installation			-		-	
Magnetic coupling			-		-	

\* Second number: two-stage design

\* Second number: two-stage design

### Pumped liquid

Water	<b>Water</b>
Wastewater	<b>Waste</b>
Oil, lubricating fluids	<b>Oil</b>
Coolant lubricants	<b>Cool</b>
Heat carrier liquids	<b>Heat</b>
Chemicals	<b>Chem</b>
Food, beverage, cosmetics, pharmaceuticals	<b>Food</b>



Series			NS		L/LV	
Max. flow rate	GPM	m <sup>3</sup> /h	3,434	780	528	120
Max. discharge pressure	PSIG	bar	145/232	10/16	363	25
Delivery head	ft	m	328/476	100/145*	820	250
Max. fluid temperature	°F	°C	284	140	284	140
Horizontal/vertical installation			●/-		●/●	
Wall/pedestal mounting			-/-		-/-	
Dry installation			●		●	
In-tank installation			-		-	
Magnetic coupling			-		-	

\* Second number: two-stage design



Water Oil

NI



Water

MI-D



Water

NAM-F

1,937	440	17,172	3,900	1,937	440
232	10/16	145	10*	232	16
311/459	95/140*	140	60	476	145
284	140	212	100	194	90
●/●		-/●		-/●	
-/●		●/●		●/●	
●		●		●	
-		-		-	
-		-		-	

\* Second number: two-stage design

\* Performance data with 60 Hz



Water

NAM/NIM



Water

MI-S/MI-C, MA-S/MA-C

10,568	2,400	7,925	1,800
145	10	145	10*
328	100*	459	140
284	140	212	100
-/●		-/●	
●/●		-/●	
●		●	
-		-	
-		-	

\* Performance data with 60 Hz

\* Performance data with 60 Hz

# CENTRIFUGAL PUMPS: Maximum Performance Data and Construction Characteristics

### Pumped liquid

Water	<b>Water</b>
Wastewater	<b>Waste</b>
Oil, lubricating fluids	<b>Oil</b>
Coolant lubricants	<b>Cool</b>
Heat carrier liquids	<b>Heat</b>
Chemicals	<b>Chem</b>
Food, beverage, cosmetics, pharmaceuticals	<b>Food</b>

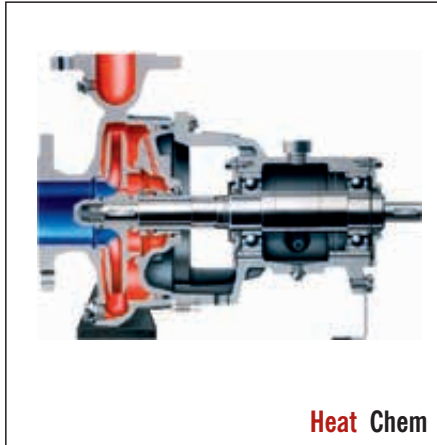

Series	ALLCHEM CNH-B		ALLCHEM CNB			
Max. flow rate	GPM	m <sup>3</sup> /h	5,300	1,200	1,057	240
Max. discharge pressure	PSIG	bar	232/363	16/25	232/363	16/25
Delivery head	ft	m	482	147	328	100
Max. fluid temperature	°F	°C	662	350	320	160
Horizontal/vertical installation			●/-		●/●	
Wall/pedestal mounting			-/-		-/-	
Dry installation			●		●	
In-tank installation			-		-	
Magnetic coupling			-		-	

### Pumped liquid

Water	<b>Water</b>
Wastewater	<b>Waste</b>
Oil, lubricating fluids	<b>Oil</b>
Coolant lubricants	<b>Cool</b>
Heat carrier liquids	<b>Heat</b>
Chemicals	<b>Chem</b>
Food, beverage, cosmetics, pharmaceuticals	<b>Food</b>

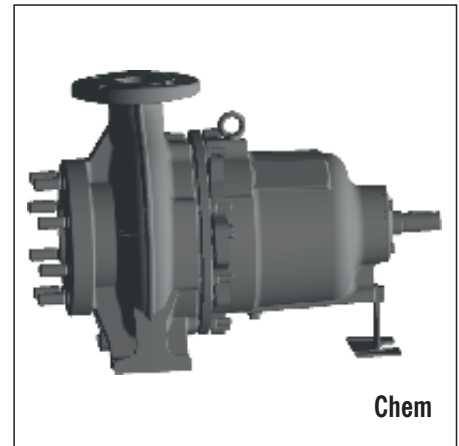
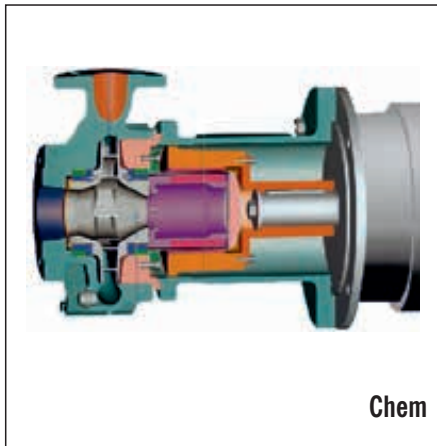

Series	ALLMAG CMA		ALLMAG CMAL			
Max. flow rate	GPM	m <sup>3</sup> /h	462	105	462	105
Max. discharge pressure	PSIG	bar	232	16	232	16
Delivery head	ft	m	180	55	180	55
Max. fluid temperature	°F	°C	302	150	302	150
Horizontal/vertical installation			●/●		●/-	
Wall/pedestal mounting			-/-		-/-	
Dry installation			●		●	
In-tank installation			-		-	
Magnetic coupling			●		●	

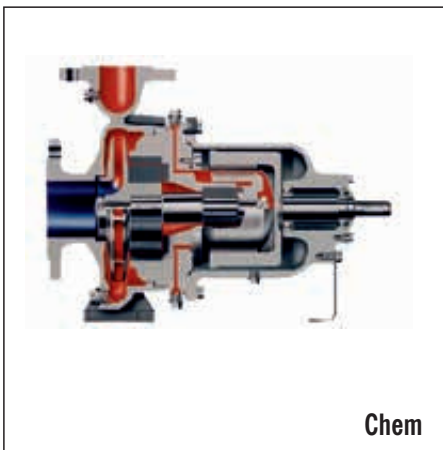

Chem



Heat Chem

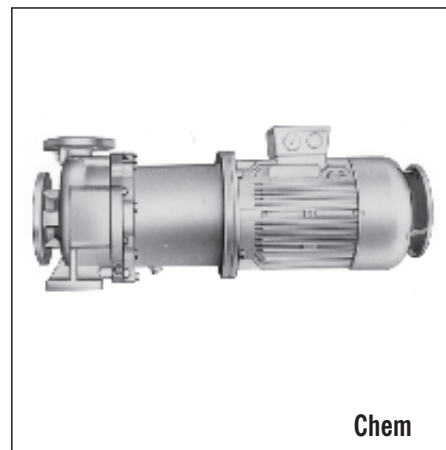

Chem

ALLMAG CNH-M		ALLMAG CNH-ML		ALLMAG CNB-M	
2,862	650	1,321	300	1,321	300
232/363	16/25	232/363	16/25	232/363	16/25
476	145	476	145	476	145
338	170	405/662	207/350*	482	250
●/-		●/-		●●	
-/-		-/-		-/-	
●		●		●	
-		-		-	
●		●		●	

\* Hot water/Heat transfer oil



Oil



Oil



Water Oil

MELO		ALLUB NSSV		NSG	
7,045	1,600	2,500*	550*	3,434	780
232	16	232	16	145/232	10/16
509	155	492	150	328/476	100/145*
212	100	212	100	284	140
-/●		-/●		●●	
-/-		-/-		●/-	
-		-		●	
●		●		-	
-		-		-	

\* Higher flow rate on request

\* Second number: two-stage design

# CENTRIFUGAL PUMPS: Maximum Performance Data and Construction Characteristics

### Pumped liquid

Water	<b>Water</b>
Wastewater	<b>Waste</b>
Oil, lubricating fluids	<b>Oil</b>
Coolant lubricants	<b>Cool</b>
Heat carrier liquids	<b>Heat</b>
Chemicals	<b>Chem</b>
Food, beverage, cosmetics, pharmaceuticals	<b>Food</b>



Series	NTT		NBT			
Max. flow rate	GPM	m <sup>3</sup> /h	5,504	1,250	1,189	270
Max. discharge pressure	PSIG	bar	232	16	232	16
Delivery head	ft	m	328/476*	100/145*	301/476	92/145*
Max. fluid temperature	°F	°C	662	350	662	350
Horizontal/vertical installation			●/-		●/●	
Wall/pedestal mounting			-/-		-/-	
Dry installation			●		●	
In-tank installation			-		-	
Magnetic coupling			-		-	

\* Second number: two-stage design

\* Second number: two-stage design

### Pumped liquid

Water	<b>Water</b>
Wastewater	<b>Waste</b>
Oil, lubricating fluids	<b>Oil</b>
Coolant lubricants	<b>Cool</b>
Heat carrier liquids	<b>Heat</b>
Chemicals	<b>Chem</b>
Food, beverage, cosmetics, pharmaceuticals	<b>Food</b>



Series	NIT		ALLMAG CMAT/CMIT			
Max. flow rate	GPM	m <sup>3</sup> /h	969	220	462	105
Max. discharge pressure	PSIG	bar	232	16	232	16
Delivery head	ft	m	301/459	92/140*	180	55
Max. fluid temperature	°F	°C	662	350	361/662	183/350*
Horizontal/vertical installation			●/●		●/●	
Wall/pedestal mounting			-/-		-/-	
Dry installation			●		●	
In-tank installation			-		-	
Magnetic coupling			-		●	

\* Second number: two-stage design

\* Hot water/Heat transfer oil



Heat

ALLHEAT NTWH

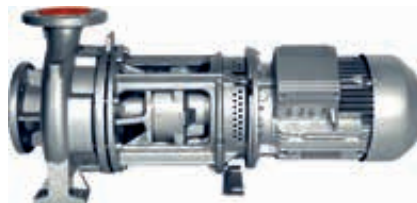

Heat

ALLHEAT NBWH

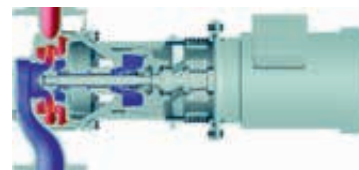

Heat

ALLHEAT NIWH

5,504	1,250	1,189	270	969	220
232	16	232	16	232	16
328	100	302	92	302	92
361/662	183/350*	361/662	183/350*	361/662	183/350*
●/-		●●		●●	
-/-		-/-		-/-	
●		●		●	
-		-		-	
-		-		-	

\* Hot water/heat transfer oil

\* Hot water/Heat transfer oil

\* Hot water/Heat transfer oil



Heat

ALLHEAT CTWH/CWH

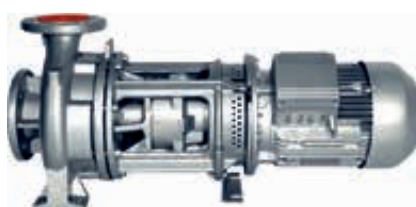

Heat

ALLHEAT CBWH

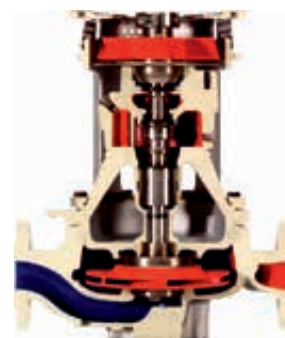

Heat

ALLHEAT CIWH

6,384	1,450	1,057	240	462	105
363	25	363	25	363	25
328	100	207	63	190	58
405/752*	207/400*	405/752*	207/400*	405/662*	207/350*
●/-		●●		●●	
-/-		-/-		-/-	
●		●		●	
-		-		-	
-		-		-	

\* Hot water/Heat transfer oil

\* Hot water/Heat transfer oil

\* Hot water/Heat transfer oil

# YOUR SINGLE SOURCE

## REDEFINING WHAT MATTERS MOST TO YOU

Pumps and fluid handling systems from trusted CIRCOR product brands – Allweiler®, Houttuin™, Imo® and Warren® – support a wide range of mission-critical applications in all types of power plants: combined cycle, combustion, steam, stationary diesel, solar power, cogeneration and hydro. Thanks to our standard and custom engineered solutions, we offer a wide range of designs for fluid handling systems in power generation applications.

Power generation operators and engineers turn to CIRCOR to help redefine the metrics that matter most to them:

- Technology: providing the right pumping and system solution for every application
- Reliability: maintaining performance of the system regardless of operating conditions
- Availability: maximizing the time for power production
- Uptime: ensuring run-time consistency without fail
- Compliance: sustaining the commitment to environmental responsibility
- Cost-effectiveness: keeping the plant competitive in a tough global economy

## REDEFINING GLOBAL SOLUTIONS

CIRCOR maintains regional engineering and manufacturing facilities to support you in your market around the world and around the clock.

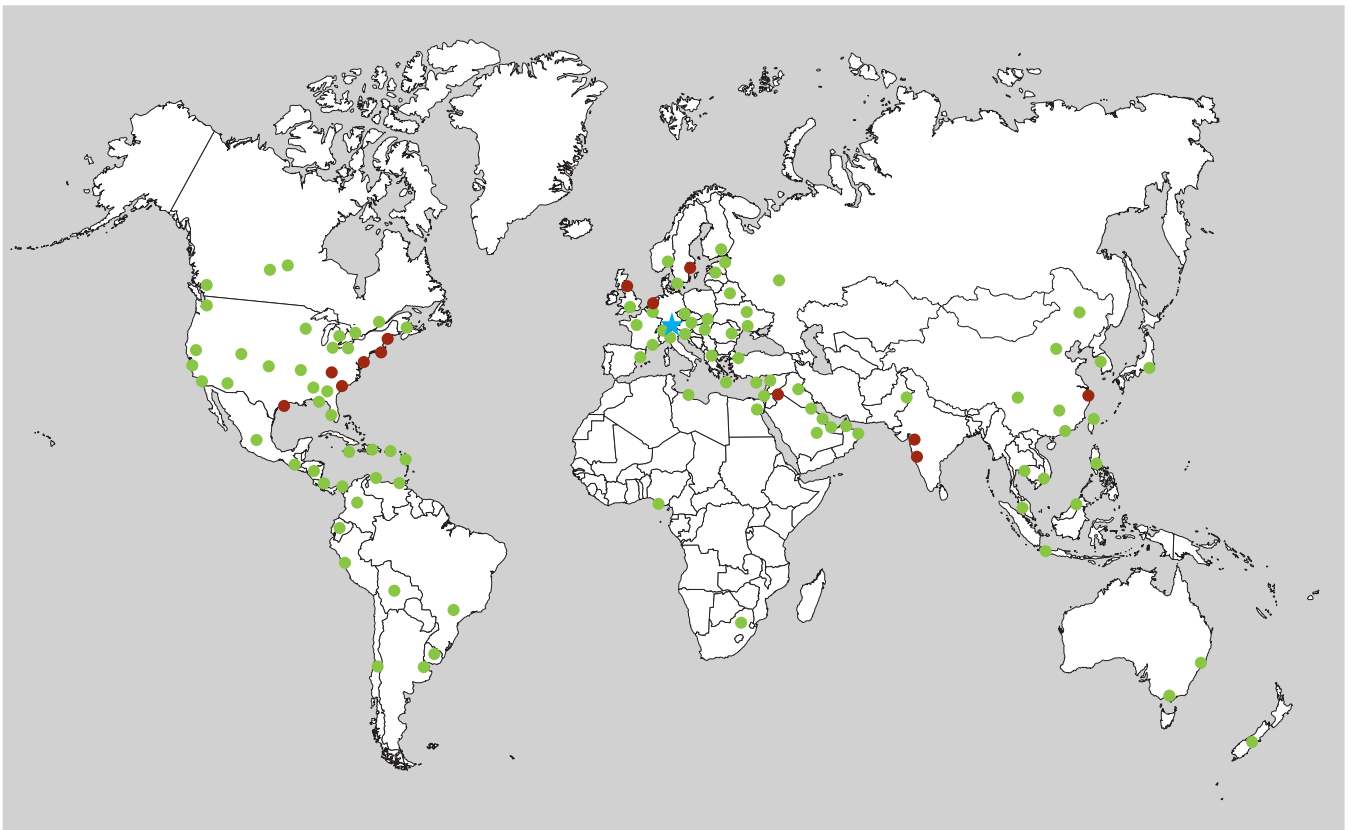

★ Global Headquarters   ● Regional Manufacturing and Engineering Support Facilities   ● Global Distributor

# POWER GENERATION

## GLOBAL SOLUTIONS

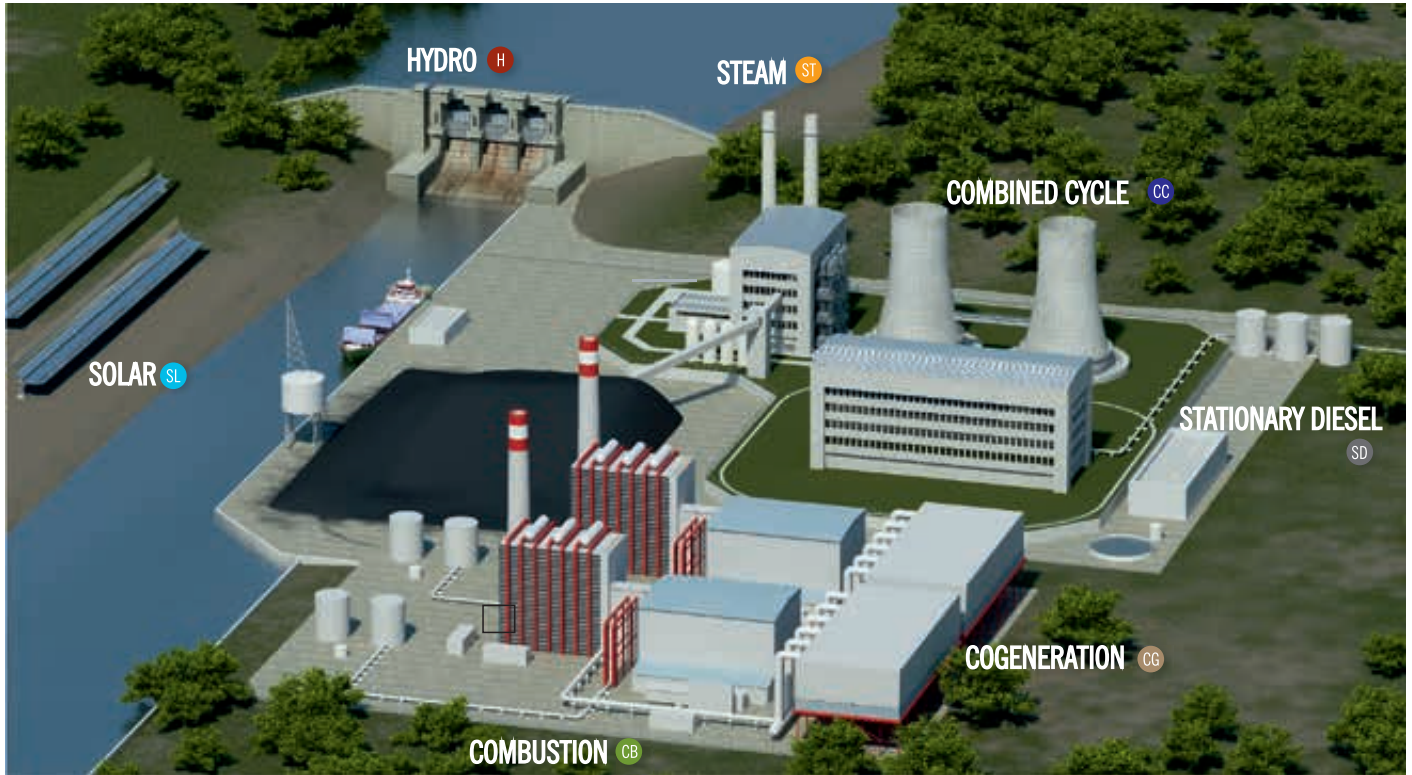

## APPLICATIONS

### H HYDRO

- Lubrication
- Hydraulic governor
- Bearing lift
- Oil service

### SL SOLAR

- Heat transfer fluids

### SD STATIONARY DIESEL

- Fuel unloading
- Fuel forwarding
- Fuel transfer
- Fuel injection
- Lubrication
- Cooling water

### CB COMBUSTION

- Fuel unloading
- Fuel forwarding
- Fuel transfer
- Rotor jacking
- Lubrication
- Fuel injection
- Chemical metering
- Seal oil

### CG COGENERATION

- Lubrication
- Rotor jacking
- Oil service
- Fuel transfer
- Fuel or burner injection

### ST STEAM

- Fuel transfer
- Fuel unloading
- Rotor jacking
- Lubrication
- Fuel or burner injection
- Waste water treatment
- Oil service
- Seal oil
- Chemical metering

### CC COMBINED CYCLE

- Fuel transfer
- Rotor jacking
- Lubrication
- Oil service
- Seal oil
- Fuel or burner injection
- Waste water treatment
- Purge water
- Washing system
- Cooling water
- NOx reduction
- Sump



## PROPELLER PUMPS

Propeller pumps are used to pump large volumes with a relatively short delivery head. They are mainly installed for circulation or acceleration of aggressive, viscous liquids and solids containing liquids in reactor circuits, crystallization or evaporation plants (as for instance in the chemical process industry, saline and potassium mining industry or food industry). Another field of application is circulating or accelerating liquids in sewage engineering and waste water plants, such as recirculation pumps, or they are applied in the area of environmental or industrial engineering (e.g. in rainwater pumping stations). The pumps are available as horizontal or vertical pumps, suspended into the pipeline or horizontally foot-mounted.

The ALLTRIMM® series was designed especially for shipbuilding applications. These space-saving inline pumps for large capacities and delivery heads of up to 20 meters have an integrated motor and reversible hydraulics.

Type of construction, materials, installation and drive can be adapted optimally to the operation and assembling conditions.

### Strengths of the technology

- A variety of propeller designs give options that are ideally suited to different operating conditions
- Optimized low NPSH requirements that minimize supply tank levels
- The most efficient solution for high flow rates and small delivery heads
- High efficiency across a broad range

Maximizing TSO\* due to

Reliable operation

Ample-sized, tapered roller bearings, lifetime grease lubricated as standard; low noise emissions.

Corrosion-resistant material

Pressure-safe pump casing with corrosion allowance.

Optimal flow conditions

Very good blade section, parabolic propeller head, elbow casing (no disturbing edges within the shaft area).

Robust construction

Designed to operate below first lateral critical speed.

High performance operation

Optimized hydraulics with very good efficiencies and NPSH values.

\*Total Savings of Ownership

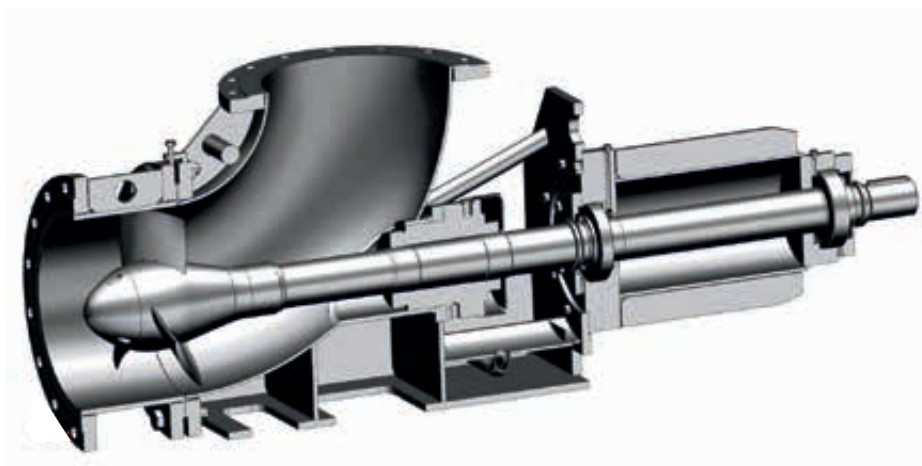

Main Applications

Chemical and process technologies, saline and potassium mining, food production, wastewater treatment and environmental engineering (e.g. flood protection), cooling water processes, shipbuilding applications, applications in locks and docks.

General advantages of the propeller pumps at a glance:

- Optimal solution for moving large flow rates.
- Several installation und material options
- Equipped with state-of-the-art shaft sealings.
- Due to an optimized rigid elbow casing, designed using Finite Element Analysis, insensitive to deformation caused by pipe forces.
- When pumping abrasive liquids, the exchangeable casing ring guarantees low replacement costs.
- Handling fluids with solids content up to 40 % by weight.

# PROPELLER PUMPS: Maximum Performance Data and Construction Characteristics

## Pumped liquid

Water	<b>Water</b>
Wastewater	<b>Waste</b>
Oil, lubricating fluids	<b>Oil</b>
Coolant lubricants	<b>Cool</b>
Heat carrier liquids	<b>Heat</b>
Chemicals	<b>Chem</b>
Food, beverage, cosmetics, pharmaceuticals	<b>Food</b>



**Water Waste Chem**

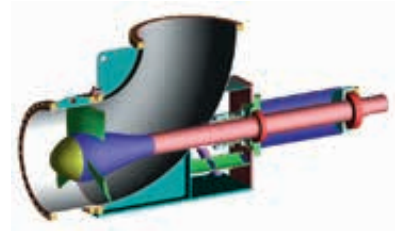

**Water Waste Chem**

## Series

### ALLPRO PGE/PGF

### ALLPRO PPR

			ALLPRO PGE/PGF		ALLPRO PPR	
Max. flow rate	GPM	m <sup>3</sup> /h	50,633	11,500	220,143	50,000
Max. discharge pressure	PSIG	bar	87	6	87	6
Delivery head	ft	m	27	8.5	39	12
Max. fluid temperature	°F	°C	392	200	392	200
Horizontal/vertical installation			●/●		●/●	
Wall/pedestal mounting			-/-		-/-	
Dry installation			●		●	
In-tank installation			-		-	
Magnetic coupling			-		-	

## OPTIMIZED IN RELATION TO ...

### SOLVING CHALLENGING DEMANDS EXCELLENTLY

A variety of propeller designs give you options that are best-suited to your operating conditions.

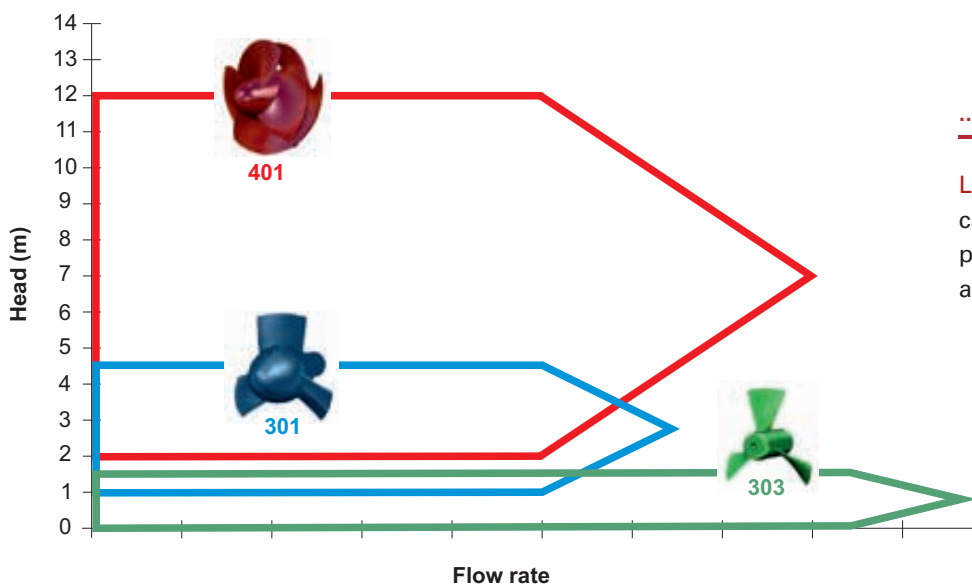

### ... HEAD

Large flow rate and head capabilities due to a range of propeller designs and blades, the angle of which can be adjusted



Chem Food

ALLPRO PUV



Waste

ALLPRO PT



Water Food

ALLTRIMM

	on request	19,813	4,500	5,724	1,300
	on request	*	*	36	2.5
	on request	4	1.5	65	20
	on request	212	100	104	40
	-/●		-/●		●/-
	-/-		-/-		-/-
	-		-		●
	bottom flange propeller pump		●		-
	-		-		-

\* Shaft seal-less submerged pump

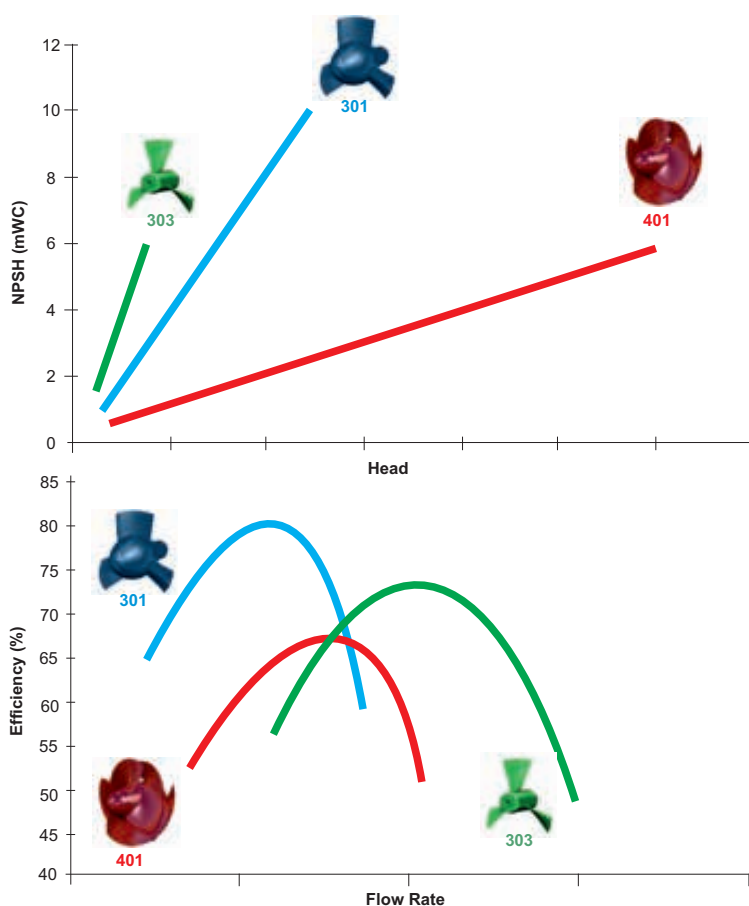

... NPSH

Optimized **low NPSH** requirements which minimize supply tank levels

... EFFICIENCY

High overall **efficiency** with minimized input power requirements and driver size, achieved by minimizing gaps between blades and casing, optimizing propeller head shape and blade profile, and using a large radius elbow casing

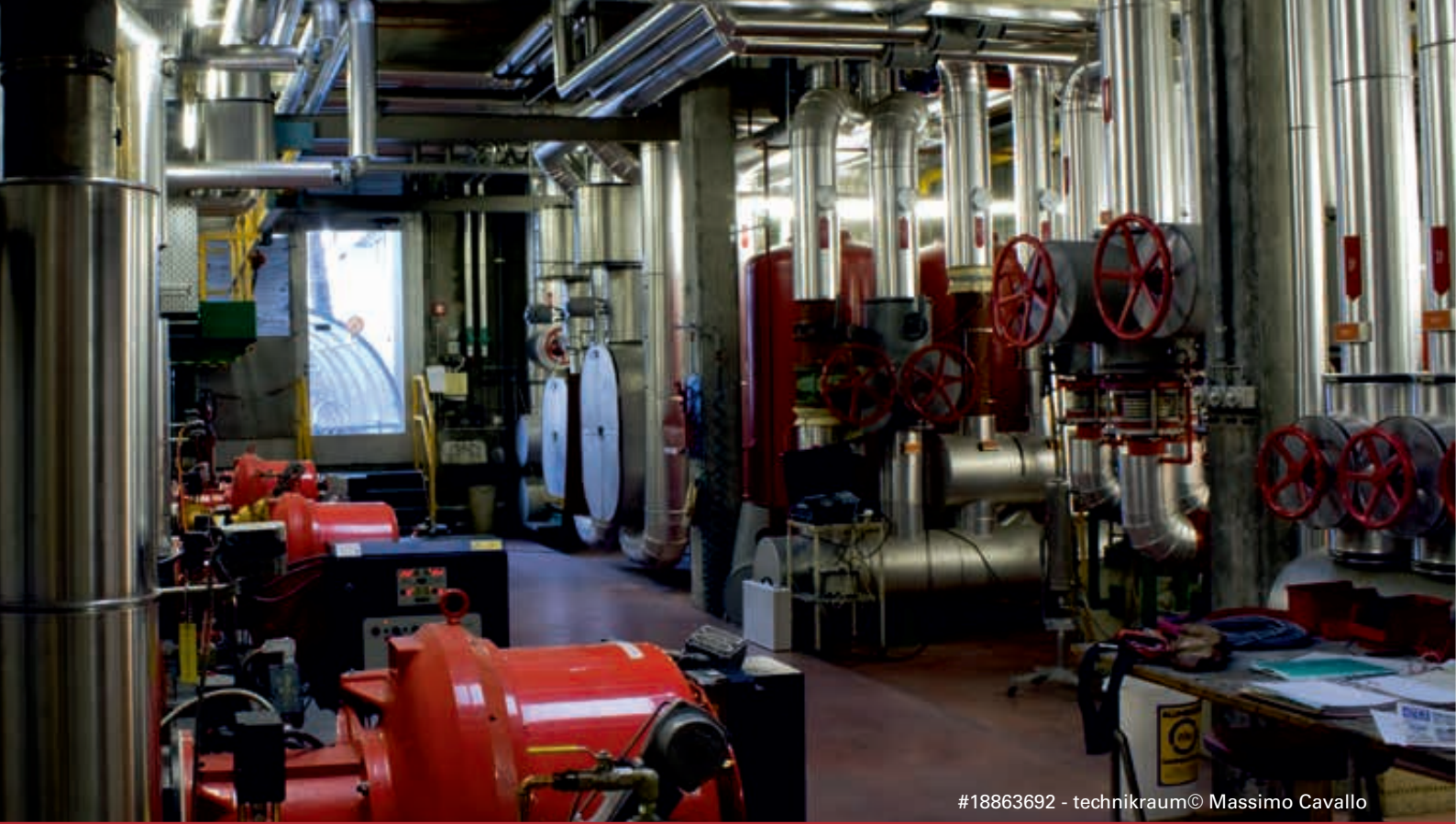

#18863692 - technikraum© Massimo Cavallo

## SIDE CHANNEL PUMPS

For handling aggressive, uncontaminated liquids, we supply self-priming side channel pumps. These pumps are used especially for applications that involve small flow rates but high delivery heads.

Designs are available that offer various advantages, especially in the event of unfavorable suction conditions or low suction heads. The pumps can be adapted to the actual fields of application; different material and shaft sealing designs according to the series are in use. Magnetic drives can also be provided.

Thanks to the side channel stage, side channel pumps have the ability to move liquids with gaseous or vapour-state components (50 %); therefore, they can also handle liquids that are slightly above their boiling points, such as liquefied gas. Side channel pumps are insensitive to cavitation at variable vapour pressures.

### Strengths of the technology

- High delivery heads
- Works even in unfavorable suction conditions or with low suction heads
- Moving fluids with gaseous or vapour-state components (50 %) and liquids that are slightly above their boiling points, like liquefied gas
- Insensitive to cavitation

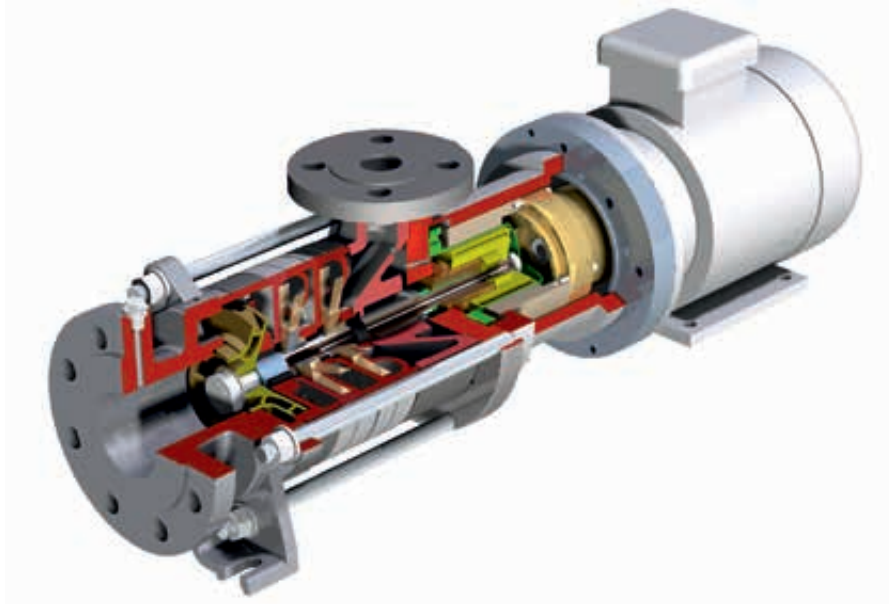

## Maximizing TSO\* due to

### Self-priming design

Open impellers guarantee a high self-priming capability. Hydraulic compensation for axial thrust.

### Robust bearing

Robust groove ball bearing, permanent grease lubrication, maintenance-free.

### Low-noise operation

Low noise level.

### Heat-resistance

Applicable for temperatures up to 220 °C/428 °F.

### Moving gaseous liquids

Side channel stage enables gases to be entrained.

### Flexible construction

Mechanical seal adapted to the requirements of the intended application.

\*Total Savings of Ownership

## Main Applications

Side channel pumps are generally used in many areas, for example: the chemical and petrochemical industry, installation and apparatus engineering, process technology, boiler feed installations, agriculture, power engineering and ship building.

### General advantages of the side channel pumps at a glance:

- Low NPSH
- Can move gaseous fluids
- Low flow, high head
- Magnetic coupling optional
- Self-priming

# SIDE CHANNEL PUMPS: Maximum Performance Data and Construction Characteristics

## Pumped liquid

Water	<b>Water</b>
Wastewater	<b>Waste</b>
Oil, lubricating fluids	<b>Oil</b>
Coolant lubricants	<b>Cool</b>
Heat carrier liquids	<b>Heat</b>
Chemicals	<b>Chem</b>
Food, beverage, cosmetics, pharmaceuticals	<b>Food</b>



Chem



Chem

Series			SRZ		SRZS	
Max. flow rate	GPM	m <sup>3</sup> /h	159	36	159	36
Max. discharge pressure	PSIG	bar	580	40	580	40
Delivery head	ft	m	1,148*	350*	1,148*	350*
Max. fluid temperature	°F	°C	428	220	428	220
Horizontal/vertical installation			●/-		●/-	
Wall/pedestal mounting			-/●		-/●	
Dry installation			●		●	
In-tank installation			-		-	
Magnetic coupling			-		-	

\* Suction head 23 ft/7 m

\* Suction head 23 ft/7 m

## Pumped liquid

Water	<b>Water</b>
Wastewater	<b>Waste</b>
Oil, lubricating fluids	<b>Oil</b>
Coolant lubricants	<b>Cool</b>
Heat carrier liquids	<b>Heat</b>
Chemicals	<b>Chem</b>
Food, beverage, cosmetics, pharmaceuticals	<b>Food</b>



Chem



Water Chem

Series			SVG/SVM		SOH	
Max. flow rate	GPM	m <sup>3</sup> /h	88	20	33	8
Max. discharge pressure	PSIG	bar	232	16	232	16
Delivery head	ft	m	170	52	492	150
Max. fluid temperature	°F	°C	248	120	248	120
Horizontal/vertical installation			-/●		●/-	
Wall/pedestal mounting			-/●		-/●	
Dry installation			●		●	
In-tank installation			-		-	
Magnetic coupling			●		-	



Chem



Oil Chem



Oil Chem

SEMA		SFH		SOHM	
88	20	88	20	30	7
580	40	363	25	323	16
820	250	820*	250*	393	120
-76...+392	-60 +200	248	120	248	120
●/-		●/-		●/●	
-/●		-/●		●/●	
●		●		●	
-		-		-	
●		-		●	

\* Suction head 23 ft/7 m



Water Chem

SOHB	
33	8
232	16
492	150
248	120
●/●	
●/●	
●	
-	
-	

## ALLWEILER® ORIGINAL PARTS:

### THE SECURITY OF KNOW-HOW

Plant operators are often unable to distinguish between cheap copies (from product pirates) and Allweiler® original parts.

The parts usually appear to be the same.

The differences are inside:

- Designed with advanced tools vs. copied without any knowledge.
- Produced from material combinations carefully developed over years and decades vs. simply copied with low-cost materials.

As the original pump manufacturer, only the Allweiler brand from CIRCOR offers the security of uniformly high quality. Quality is assured through a conscientious design and high-quality materials. Every part meets our DIN/EN/ISO-certified quality standards. For these reasons, the investment in original parts is always prudent: Longer service lives of the parts, longer maintenance intervals, higher efficiency, and predictable maintenance cycles are just a few of the benefits that boost the value of original parts.



#18223661 © maurosessanta

## GEAR PUMPS

Over the years CIRCOR's company Zenith® has been distinguished as an innovator in the application of gear pump technology by numerous industries and end users. CIRCOR offers a complete line of gear pumps and metering systems to handle all critical applications in industrial production processes.

To succeed in today's competitive environment, the proper selection and care of a plant's many precision gear pumps is of particular importance. Our state-of-the-art production equipment provides the close tolerances and precision machining necessary for high-performance pumping. We provide tolerances on many of our parts to +/- 50 millionths of an inch. As a result, we can produce pumps with total axial and diametrical gear clearances of 0.0003 inches (0.0076 mm) in total or 0.00015 inches (0.0038 mm) on either side and around the periphery of the gears. This precision not only ensures pump volumetric efficiency; it also adds to the longevity and uniformity of the pumps on your fiber production equipment.

With world-class ISO 9001 certified production facilities utilizing the latest computer-controlled, high precision manufacturing equipment, Zenith® Pumps maintains a leading position among precision gear pump manufacturers. Advanced measuring equipment with accuracies up to four millionths of an inch enable Zenith® Pumps to guarantee pump-to-pump accuracy and repeatability within a range of one percent.

### Strengths of the technology

- Outstanding stream-to-stream and pump-to-pump metering uniformity over a wide range of process conditions
- Superior pump pressure and viscosity capability
- Superior pump life and toughness
- Reduced polymer shear and downstream thermal gradients
- Packaged additive metering systems for continuous, accurate addition of processing aids, including colorants, plasticizers, and others, to the mainline process.



## Main Applications

Handling the many critical applications in industrial production processes, such as in the food and beverage, adhesive/sealant, man-made fiber, paint and coatings, multi-component/polyurethane, polymer/extrusion, cosmetics and general industries, and all other chemical or polymer fluid metering applications.

### General advantages of the gear pumps at a glance:

- Precise, pulseless and uniform metering
- Superior pump pressure and viscosity capability
- Long pump life and high durability

## Maximizing TSO\* due to

### High accuracy

Stable, repeatable flows are assured under varying conditions of temperature, viscosity and pressure.

### Uniform metered flow

Unique design offers a virtually pulseless flow, without valves or flexible elements that add complexities, increase cost and hinder performance.

### Engineered solutions

A variety of pump heads and driver combinations have been pre-configured to provide a range of standard installation options, meeting OSHA, UL, EC and DIN standards.

### Active flow meter concept

Unparalleled mechanical precision, combined with closed loop accuracy, ensures exact volumes per revolution without expensive flow meters.

### Low maintenance costs

Only three moving parts, and hardened abrasion resistant materials provide excellent wear, corrosion and self-lubricating performance.

**\*Total Savings of Ownership**

# EXTERNAL GEAR PUMPS: Maximum Performance Data and Construction Characteristics

## Pumped liquid

Water	<b>Water</b>
Wastewater	<b>Waste</b>
Oil, lubricating fluids	<b>Oil</b>
Coolant lubricants	<b>Cool</b>
Heat carrier liquids	<b>Heat</b>
Chemicals	<b>Chem</b>
Food, beverage, cosmetics, pharmaceuticals	<b>Food</b>



Chem



Chem

## Series

### PEP II

### Planetary

		PEP II		Planetary	
Max. flow rate	cc/min	30,000		1,480	
Max. discharge pressure	PSIG bar	10,000	690	7,200	500
Viscosity	mm <sup>2</sup> /s	1 to 2,000,000		1 to 2,000,000	
Max. fluid temperature	°F °C	950	510	950	510
Horizontal/vertical installation		●●		●●	
Wall/pedestal mounting		-/●		-/●	
Dry installation		●		●	
In-tank installation		-		-	
Magnetic coupling		-		-	

## Pumped liquid

Water	<b>Water</b>
Wastewater	<b>Waste</b>
Oil, lubricating fluids	<b>Oil</b>
Coolant lubricants	<b>Cool</b>
Heat carrier liquids	<b>Heat</b>
Chemicals	<b>Chem</b>
Food, beverage, cosmetics, pharmaceuticals	<b>Food</b>



Chem



Chem

## Series

### H-9000

### 9000MD

		H-9000		9000MD	
Max. flow rate	cc/min	27,000		4,500	
Max. discharge pressure	PSIG bar	2,500	175	1,000	70
Viscosity	mm <sup>2</sup> /s	1 to 100,000		0.5 to 50,000	
Max. fluid temperature	°F °C	950	510	401	205
Horizontal/vertical installation		●●		●/-	
Wall/pedestal mounting		-/●		-/●	
Dry installation		●		●	
In-tank installation		-		-	
Magnetic coupling		-		●	



Oil

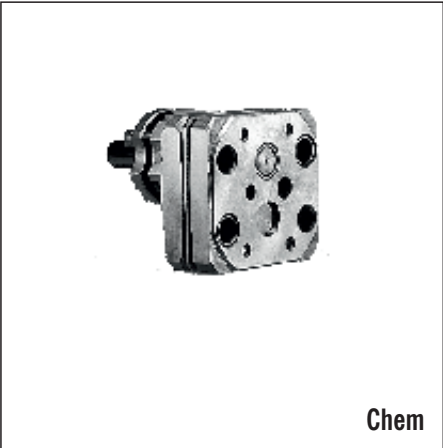

Chem



Chem Food

CIG (Internal Gear)		H-Series		B-Series	
473,176		36,000		36,000	
5,000	345	4,000	275	3,000	207
0.5		1 to 2,000,000		1 to 2,000,000	
180	82	950	510	298	148
●/●		●/●		●/●	
-/-		-/●		-/-	
●		●		-	
●		-		-	
-		-		-	



Chem



Chem Food



Chem

B-9000		C-9000		Chameleon	
27,000		9,000		1,800	
1,000	70	1,000	70	1,000	69
1 to 100,000		1 to 50,000		1 to 100,000	
644	340	347	175	302	148
●/●		●/●		●/●	
-/●		-/●		●/●	
●		●		●	
-		-		-	
●		-		-	

**Pumped liquid**

Water	<b>Water</b>
Wastewater	<b>Waste</b>
Oil, lubricating fluids	<b>Oil</b>
Coolant lubricants	<b>Cool</b>
Heat carrier liquids	<b>Heat</b>
Chemicals	<b>Chem</b>
Food, beverage, cosmetics, pharmaceuticals	<b>Food</b>

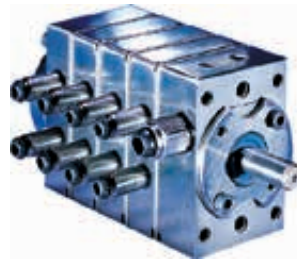

**Chem**



**Chem**

Series		Spin Finish		BB PEP	
Max. flow rate	cc/min	120		3	
Max. discharge pressure	PSIG bar	100	7	4,800	330
Viscosity	mm <sup>2</sup> /s	1 to 100		1 to 2,000,000	
Max. fluid temperature	°F °C	212	100	950	510
Horizontal/vertical installation		●/-		●/●	
Wall/pedestal mounting		-/●		-/●	
Dry installation		●		●	
In-tank installation		-		-	
Magnetic coupling		-		-	

## ON-SITE SERVICE:

**LOW OPERATING COSTS, LOW AND PREDICTABLE MAINTENANCE COSTS, OPTIMIZED POWER CONSUMPTION**

How can you operate your pumps in the most cost-effective way possible? Our consultation will provide you with concrete tips for using your pumps efficiently. We will help you reduce energy costs and expenses for spare parts and maintenance.

You will benefit directly from our experience with hundreds of installations around the world. We have decades of experiences in a wide variety of industries and with all types of liquids and pumping tasks.

Our evaluations have shown that the greatest potential for savings is in the area of energy and maintenance costs. So we do more than just hold presentations and training events. We take the time to analyze and fully document the status and operating conditions of your pumps.

Based on this, our experts provide you with practical tips on how you can lower energy expenses by improving the efficiency of your pumps. We also introduce you to proven methods for optimizing your usage of spare parts and minimizing costs associated with stock-keeping. If problems do arise, our experts will be ready to provide assistance. They are eager to show you proven methods for lowering operating costs and optimizing the way you use your pumps.

## ALLWASTE® : IDEAL FOR ALL LIQUIDS IN A CLARIFICATION PLANT

The ALLWASTE® product family is a refined modular system where you can find the right pump for your needs. You can choose from an entire line of pumps that employ a variety of pumping principles in order to find the pump type that most ideally suits the needs of your plant and provides the most economic and environmentally friendly option. The pumped liquids include raw wastewater, various types of sludges (raw and preclarification sludge, return sludge, excess sludge, slurry and activated sludge), suspensions, flocculent aids, milk of lime, filtrates and service water. If you decide to use an ALLWASTE® pump, you can count on rapid service at your location no matter where you are in the world. QuickServe® delivers original replacement parts within a defined reaction time. In addition, PumpService® will be on the job as soon as you need qualified experts at your plant.

The CIRCOR Allweiler® brand offers a level of security that almost no other manufacturer can provide: stators from our own production. We can quickly and economically deliver stators for progressing cavity pumps made from about 20 different materials. All stators come directly from our plant, even unusual sizes and those using uncommon materials.

Pumped liquid	Pump type					
	Progressing Cavity Pumps	Macerators	Peristaltic Pumps	Centrifugal Pumps	Propeller Pumps	Screw Pumps
Untreated sewage	●	●		●	●	
Faecal/untreated/fresh sludge	●	●				
Excess sludge	●	●	●			
Return sludge	●		●		●	
Circulated sludge (Denitrification/Nitrification)					●	
Pre-setting sludge	●	●	●			
Digested sludge	●	●	●			
Lime milk suspension, neutralising agents	●		●	●		
Ferric chloride solution, precipitating agents	●		●	●		
Concentrated sludge	●	●	●			
Polyelectrolyte, flocculant parent solution	●		●			
Flocculating additaments	●		●			
Slurry, dewatered sludges with up to 45 % DS content	●		●			
Scum	●	●				
Press water, filtrate, centrate		●		●		
Sampling (sewage, sewage water, sludges)	●	●	●			
Fresh/industrial/process water				●		
Cleaning/sealing water				●		
Adsorbents/oxydants/disinfectants	●		●	●		
Thermal oil, hot water				●		
Light/heavy oils				●		●



## PERISTALTIC PUMPS

Allweiler® peristaltic pumps are dry self-priming, seal-less and valve-less rotary displacement pumps. They are popular for pumping or metering thin to highly viscous liquids, pasty, neutral or aggressive, pure or abrasive liquids, gaseous liquids or liquids that tend to foam, even liquids with fibrous and solid components.

### Strengths of the technology

- Short, flexibly clamped pump hose for extended life
- Efficient pressure and priming characteristics through hoses with several textile-reinforced elastomer options
- Gentle compression of pump hose through adjustable and patented sliding blocks
- Dry run capabilities due to design features, lubrication and cooling inside the pump casing

### Pumped liquid

Water	<b>Water</b>
Wastewater	<b>Waste</b>
Oil, lubricating fluids	<b>Oil</b>
Coolant lubricants	<b>Cool</b>
Heat carrier liquids	<b>Heat</b>
Chemicals	<b>Chem</b>
Food, beverage, cosmetics, pharmaceuticals	<b>Food</b>



Water Chem Food

Series	ASH			
Max. flow rate	GPM	m <sup>3</sup> /h	264	60
Max. discharge pressure	PSIG	bar	232	16
Viscosity	mm <sup>2</sup> /s		100,000	
Max. fluid temperature	°F	°C	176	80
Horizontal/vertical installation	●/-			
Wall/pedestal mounting	-/●			
Dry installation	●			
In-tank installation	-			
Magnetic coupling	-			



### Maximizing TSO\* due to

#### Long hose life

Patented elastic inclusion of the pump hose; pump hoses in different elastomer qualities – specially wound, fabric-reinforced, and polished.

#### Low operating temperature

Patented sliding block/rotor and casing combination reduces the working temperature.

#### Robust hoses

Hose with several textile-reinforced elastomer options.

#### Variety of connections

Different types of connections are available

\*Total Savings of Ownership

### Main Applications

Used in wastewater engineering, the food industry and chemical and petrochemical industries.

#### General advantages of the peristaltic pumps at a glance:

- Self-priming
- Seal-less
- Valve-less
- Wide viscosity range
- Compatible with fluids that have a high load of solids and large solids
- Low operating noise
- Capacity control via speed regulation
- Good efficiency
- Low wear
- Reliable during operation
- Compact space saving design
- Long service life

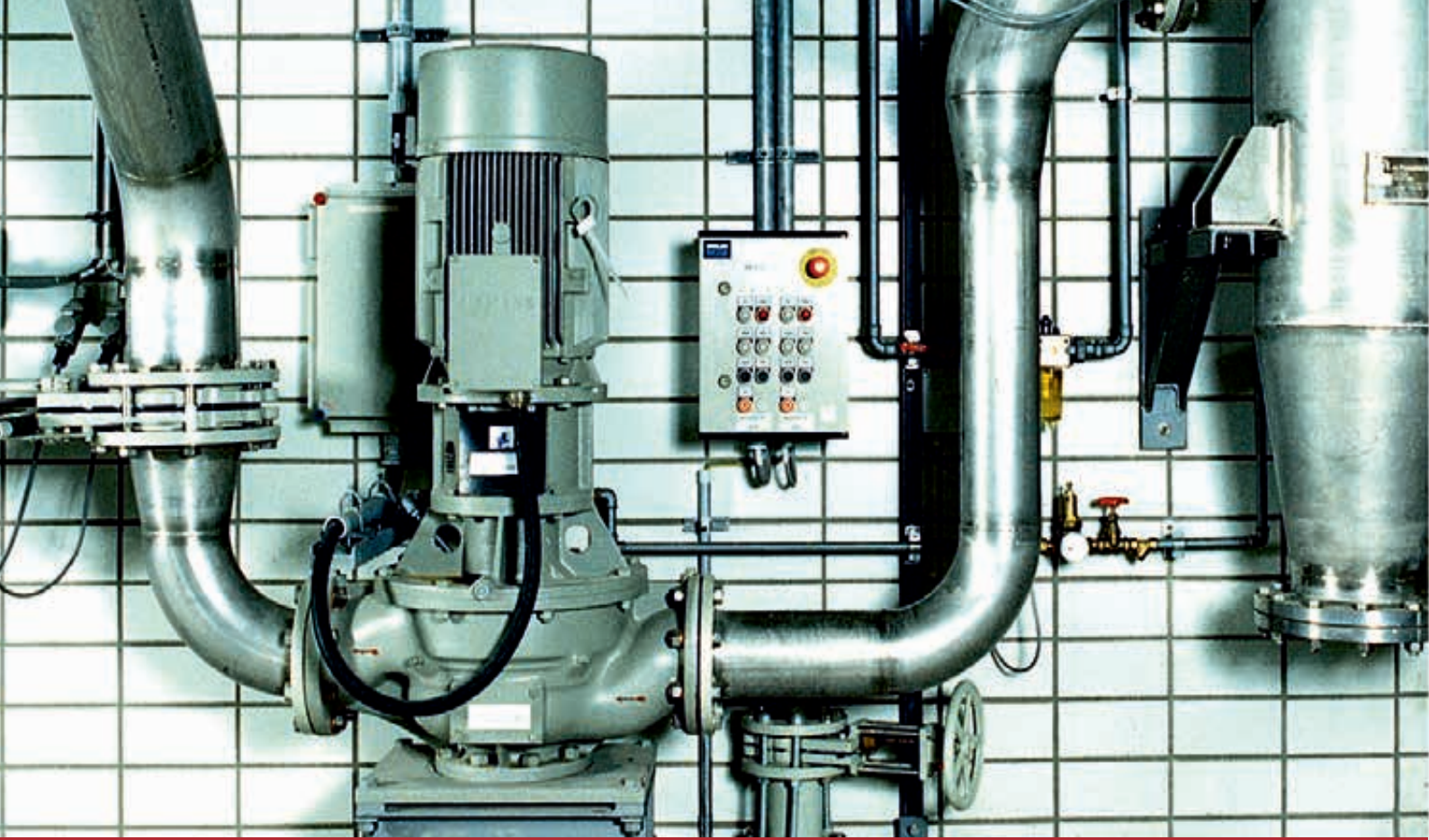

## MACERATORS

Allweiler® macerators have the task of crushing any solids contained in liquids, such as wood, textiles, plastic, paper, rubber, bone, fur, glass, etc. and making them pumpable. The chopping elements are the rotating impeller and the stationary cutting ring. Allweiler® macerators are supplied as collecting macerators with a 3-5 m (9-16 ft) built-up delivery head (attachment to basins, tanks) or as inline macerators with a downstream-arranged progressing cavity pump for direct installation in the pipeline.

### Main Applications

Macerators are used for chopping, mixing, and process technology applications; in communal and industrial wastewater treatment plants; and in the treatment of waste products in every industrial segment.

### Strengths of the technology

- Bi-directional rotation capabilities double the life time of a macerator
- S-Version macerators can overcome a head of 3 -5 m (9 to 16 ft) without an additional pump

### General advantages of the macerators at a glance:

- Chop solids and produce pumpable liquids that contain fibers and solids.
- Durable and robust design
- Replaceable cutting tips
- Can be adapted to customer needs

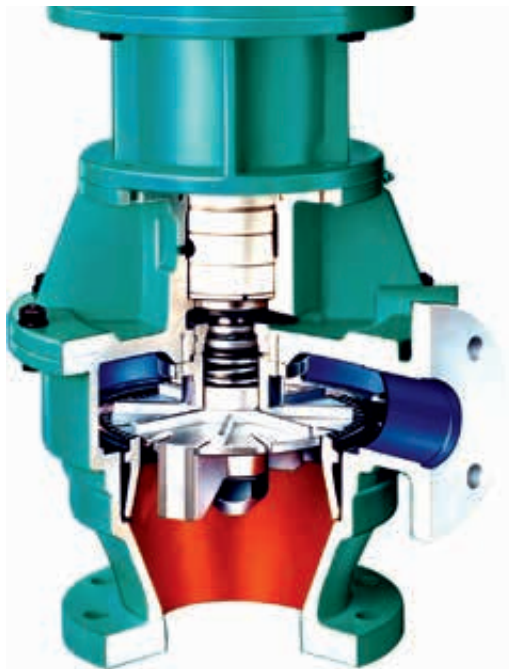

**Maximizing TSO\* due to**

**Efficient operation**

Two crushing stages (milling cutter/cutting teeth and slotted cutter disc/toothed rings) for grain sizes of 3.5 mm/0.14 inch or fiber sizes of 1.5 cm<sup>2</sup>/0.016 ft<sup>2</sup>.

**Variety of designs**

Bare shaft or block design.

**Flexible construction**

The degree of size reduction is especially tuned to facilitate subsequent pumping with progressing cavity pumps.

**\*Total Savings of Ownership**

Pumped liquid	
Water	<b>Water</b>
Wastewater	<b>Waste</b>
Oil, lubricating fluids	<b>Oil</b>
Coolant lubricants	<b>Cool</b>
Heat carrier liquids	<b>Heat</b>
Chemicals	<b>Chem</b>
Food, beverage, cosmetics, pharmaceuticals	<b>Food</b>



Series	AM		ABM			
Max. flow rate	GPM	m <sup>3</sup> /h	705	160	80	7
Max. discharge pressure	PSIG	bar	7	0.5*	7	0.5*
Viscosity	mm <sup>2</sup> /s					
Max. fluid temperature	°F	°C	176	80	176	80
Horizontal/vertical installation			●/-		●/●	
Wall/pedestal mounting			●/-		●/-	
Dry installation			●		●	
In-tank installation			-		-	
Magnetic coupling			-		-	

\* built-up delivery head 9-16 ft/3-5 m

\* built-up delivery head 9-16 ft/3-5 m



## IN-1000 - Intelligent pump monitoring

With its SmartTechnology IN-1000 Series, CIRCOR is defining a new generation of condition monitoring. IN-1000 is an electronic and fully automated monitoring system. The modular design of IN-1000 permits easy integration into pump systems, with pre-configured settings that are the basis for rapid, individualized startup. The IN-1000 may be retrofitted at any time and allows central monitoring of up to 10 satellites with one control.

The new SmartTechnology IN-1000 series is ready to handle anything from straightforward condition monitoring to more complex monitoring activities, including operation monitoring of multiple pumps for simultaneous fulfillment to ensure your safety and operating cost requirements are met. Operations are monitored continuously and automatically, with activity logging and storage to enable your processes to be analyzed. If unusual operating conditions occur, both audible and visual alerts are triggered and shown on a graphics-capable color display.

Because of these capabilities, maintenance and repairs can be planned in advance, there are no unplanned production downtimes or consequential damages, and maintenance intervals are extended. As a result, expenses for maintenance and spare parts are reduced and the long service life of each CIRCOR pump/motor assembly can be utilized to its fullest extent.

### IN-1000 in use:

Each network of the IN-1000 modular diagnostic system may contain up to 11 (1 master and 10 satellites) communicating modules. Master-master communication is possible for the purpose of establishing a complex network.

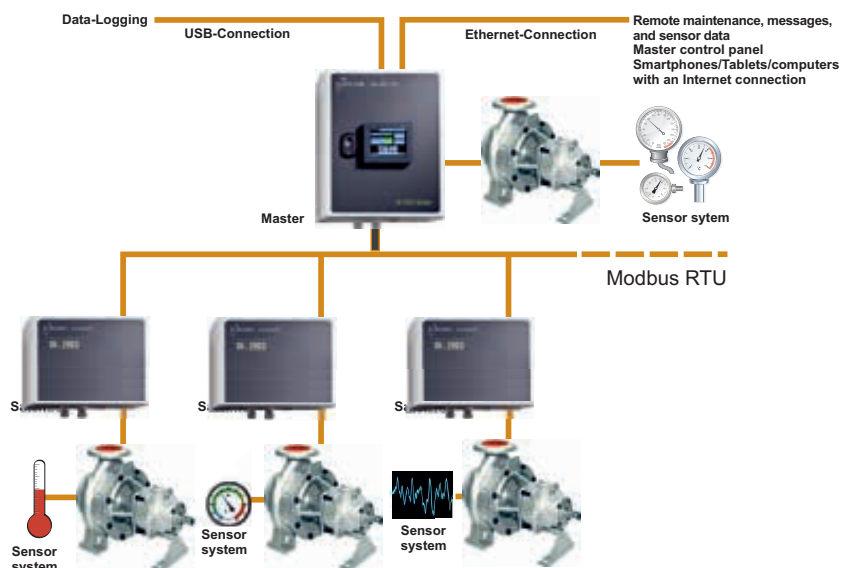

© 123RF Stock Foto

## VSD - New screw pump sets reduce operating costs by up to 40 %

---

The new generation of screw pumps from CIRCOR reduces the operating costs by up to 40 %. As complete pump sets consisting of the pump, motor, and a frequency converter, they achieve these savings without additional investment. CIRCOR promises a leap forward in technology that dramatically reduces operating costs of screw pumps for the first time in decades – without any extra investment. The foundation of the solution is the Variable Speed Drive (VSD), which uses 87-Hz technology. The new generation of screw pumps combines two developments to reduce operating costs. In the past, it was necessary to compromise on pump size and screw pitch in order to obtain the desired capacity range, but now with VSD the required capacity is achieved with pinpoint accuracy. Even better, the system can be easily adjusted when system or operating conditions change. A complete pump set consisting of the pump, motor, and frequency converter replaces a pump with a free shaft end. All three components are configured precisely at the factory and adjusted for optimal achievement of the desired capacity. For virtually the same price, customers receive a complete VSD pump set that is significantly more efficient. By optimizing configuration of the components, the negative effects of oversized pumps can be counteracted. As a result, pump operators save space and money.

## ALLSPEED® - Dynamic control system without valves

---

ALLSPEED® forgoes the use of valves and enables use of smaller pumps and a smaller motor. Standard cage rotor motors may be used without external ventilation. ALLSPEED® supplements the EMTEC® series, which is designed specifically for pumping coolants in tool machines..

The core element of ALLSPEED® is a control algorithm developed by the CIRCOR Allweiler brand. Results include: a real-time adaptive control of the frequency converter, the pump can adapt to specific tools with a reaction time of less than 500 ms, speed jumps of up to 5,000 1/min are possible, pressure differences of up to 120 bar can be handled, approaching the tool's operating points without overshoots and continuous readjustments, the pump can be stopped as soon as the pumping of coolant is stopped, standby losses and standby costs are virtually zero. Additional benefits include monitoring of the motor temperature, capacity adjustments in marginal areas, and warning messages.

Use of ALLSPEED® in conjunction with EMTEC® pumps significantly lowers energy costs by up to 75 % and also produces additional financial benefits, e.g. use of low-pulsation screw pumps instead of the more common centrifugal pumps up to 25 bar.



## ENGINEERED SYSTEMS

---

CIRCOR is a preeminent supplier of a variety of fluid handling systems including fuel oil systems, packaged units, point-to-point box lubricators, API (Chapter 2 and Chapter 3) and non-API lubrication systems and other highly engineered systems for a wide variety of applications.

In addition, CIRCOR is a preeminent global supplier of multiphase pumping technology and other highly-engineered fluid handling systems for the oil and gas industry. Leveraging their gas handling expertise, they also provide skid-mounted gas compression systems and natural gas chillers for the upstream sector. These capabilities provide CIRCOR with the tools to effectively manage the needs of production field operators in handling gas, oil or a multiphase mixture.

### **Main Applications**

Especially in oil and gas, power and industry and commercial marine markets

## API 614/610 lubrication Systems

---

Similar to any lubrication system that provides constant lubrication and protection for compressors, steam and gas turbines and diesel engines, the API 610 and API 614 lubrication systems provide lubrication to rotating equipment used to support process operations. API 614/610 pumps and lubrication systems are used throughout the upstream, midstream and downstream sectors of the oil and gas industry. These systems also utilize pumps, strainers or filters, relief valves, piping and heat exchangers to provide the necessary lubrication throughout a wide operation range. The pump used within a API 610/614 lubrication system is typically provided by either IMO®, Allweiler® or IMO AB branded three-screw pump.

Users operating centrifugal pumps in a refinery environment may also consider Oil Mist Generators provided by Total Lubrication Management. Oil Mist Generators support multiple centrifugal process pumps within a refinery and offer exceptional value, particularly in hazardous environments.

## Non-API lubrication systems

---

Non-API lubrication systems are essential products and services that ensure reliability throughout the plant by providing lubrication to rotating equipment such as main journal bearings, generator bearings, reducing gears, and accessory gears. OEM's and plant operators who want to ensure the plant operates with maximum efficiency and reliability will specify lubrication systems for each piece of rotating equipment.

Depending on the system requirements, other items such as oil purifiers or rundown tanks may also be required. Lubrication systems in power plant applications are typically installed with the pumping systems mounted in a vertical configuration, with a primary, standby and emergency backup. Occasionally, the lubrication system is configured with a control oil system, taking the number of pumps in the system to five. For steam and gas turbines above 50MW, where flow rates are significantly higher, the preferred pump is a centrifugal pump such as the Allweiler® branded NSSV series. Turbines, diesel engines and compressors units below this output range are supported with either three-screw or gear pumps.

## Dry gas seal systems

---

Dry gas seal (DGS) systems are used throughout the process industry to provide positive shaft sealing on compressors and other rotating machines, in order to prevent the release of potentially harmful gasses or substances into the surrounding atmosphere. The use of gas as the sealing medium has increasingly replaced oil, which was widely used for this purpose in the past, as gas seal technology has improved over the last 20 years.

It is true that most of the gas seal manufacturers can also provide a simple DGS system, which may suit a customer's need. In cases where the DGS is required to meet unique project or process specifications, the compressor OEM may need to turn to a specialist such as CIRCOR to provide a more personalized solution for their particular application. Users operating centrifugal pumps in a refinery environment may also consider Oil Mist Generators provided by Total Lubrication Management. Oil Mist Generators support multiple centrifugal process pumps within a refinery and offer exceptional value, particularly in hazardous environments.

## CIRCOR

---

ALLWEILER GmbH  
Allweilerstr. 1  
78315 Radolfzell  
Germany

1710 Airport Road  
Monroe, NC 28110  
USA

No.120 Jinnuo Road  
Weihai, Shandong 264200  
China

No. 2679 Hechuan Road  
Shanghai 201103  
China

Tel. +49 7732 86 0

Tel. +1 704 289 65 11

Tel. +86 631 5386 953

Tel. +86 021 64791017

[www.circor.com](http://www.circor.com)



*Power & Industry, Oil & Gas & Commercial Marine Products & Services*

---

**ALLWEILER® HOUTTUIN™ IMO® WARREN® ZENITH®**

All data and information are non-binding and do not represent a binding description of performance that is current at all times. This brochure is intended for informational purposes. The right to changes and errors is reserved.

CIRCOR, ALLWEILER, IMO, TUSHACO, WARREN and ZENITH are registered trademarks and HOUTTUIN is a trademark of CIRCOR or its subsidiaries in the U.S. and/or other countries. (c) 2021, CIRCOR. All rights reserved. 488177 - 2021.08